

**This document is downloaded from CityU Institutional Repository,  
Run Run Shaw Library, City University of Hong Kong.**

Title	The effects of curing conditions on mortars using glass powder as cement replacement material
Author(s)	Choi, Ho Kin Tommy (蔡浩健)
Citation	Choi, H. K. T. (2014). The effects of curing conditions on mortars using glass powder as cement replacement material (Outstanding Academic Papers by Students (OAPS)). Retrieved from City University of Hong Kong, CityU Institutional Repository.
Issue Date	2014
URL	<a href="http://hdl.handle.net/2031/7456">http://hdl.handle.net/2031/7456</a>
Rights	This work is protected by copyright. Reproduction or distribution of the work in any format is prohibited without written permission of the copyright owner. Access is unrestricted.

# **The Effects of Curing Conditions on Mortars Using Glass Powder as Cement Replacement Material**

By

Ho Kin Tommy CHOI

Submitted in partial fulfillment of the requirements for  
the degree of Bachelor of Engineering (Honours) in Building Engineering  
(Construction Engineering and Management)

Department of Civil and Architectural Engineering  
City University of Hong Kong

April 2014

## ABSTRACT

The likelihood of adopting fine glass powder as a cement replacement material to protect the environment was examined by three types of experiments, including compressive strength test, sorptivity test and pundits test. To promote the comprehensiveness of this research, different curing conditions, namely air curing, 27°C water curing and 60°C water curing, were applied to the specimens. The investigated level of cement replacement were 0%, 20%, 40% and 60%. For the influences of level of cement replacement, all the properties of mortar were weakened by the increase of level of cement replacement, except the sorptivity; 40% cement replacement was the optimum level for the development of sorptivity. Larger glass particle size than cement was believed to be the reason of the above observation. In regard of the influences of curing conditions, firstly, water curing were more conducive to the performances of the specimens than air curing. Secondly, 60°C water curing promoted the early, day3 and day7, performances of the all specimens, but sometimes it was deleterious to the day60 performance. For example, the day60 compressive strength of the 60°C water cured specimens were lower than the 27°C water cured specimens, as a result of crossover effect; the development of pulse velocity in 60°C water curing were also limited by the same reason. Only the sorptivity of all samples in all age could be benefited by 60°C water curing. Apart from the influences of curing conditions and level of cement replacement, facts about correlations of pulse velocity and compressive strength were found. It is found that the slope of the linear correlation were very sensitive to the curing conditions and level of cement replacement.

# ACKNOWLEDGEMENT

Firstly, I would like to dedicate my most sincere appreciation to **Dr. LO, Yiu Tommy**, the associate professor of the Department of Civil and Architectural Engineering of City University of Hong Kong for his supervision and guidance for the project in question. This project would not have been accomplished without his kind devotion of his time.

Secondly, I would also like to thank the technical staff, **Mr. Alan Chan, Mr. Cheung and Mr. Mak**, without their supports on the technical aspects, this project would not have been done smoothly.

Lastly, I would like to show my gratitude to my fellow classmates who work closely together to accomplish this final year project.

# TABLE OF CONTENT

DECLARATION.....	i
ABSTRACT.....	ii
ACKNOWLEDGEMENT .....	iii
TABLE OF CONTENT .....	1
LIST OF FIGURES .....	4
LIST OF TABLES .....	7
LIST OF PHOTOGRAPHS .....	7
LIST OF EQUATIONS.....	7
CHAPTER 1 INTRODUCTION .....	8
1.1 Background.....	8
1.2 Objective .....	9
1.3 Outline.....	10
CHAPTER 2 LITERATURE REVIEW.....	11
2.1 Strength .....	11
2.1.1 The effects of water curing of different temperatures toward the compressive strength of the plain cement mortars.....	11
2.1.2 The effect of curing temperature of water on the pozzolanic activity of the glass powder ..	13
2.1.3 The effect of cement replacement percentage and fineness on compressive strength of cement mortar .....	15
2.2 Sorptivity.....	18
2.2.1 The effect of replacing cement by glass powder of different fineness and percentage to the sorptivity of the specimens .....	18
2.2.2 The effect of different curing conditions to the sorptivity of the plain cement mortar.....	22
2.3 Pulse Velocity.....	24
2.3.1 The effect of different curing conditions to the pulse velocity of plain cement mortar .....	25
2.3.2 The effect of applying pozzolanic material to replace cement in regards of pulse velocity .	26
2.3.3 The relationship between Pulse velocity and compressive strength.....	28
2.4 Pozzolanic Reaction of Glass Powder.....	29
CHAPTER 3 METHOD AND MATERIAL.....	30

3.1	Mixing Design and testing Schedule.....	30
3.2	Material and apparatus .....	31
3.3	Mixing and Curing .....	36
3.4	Compressive strength.....	38
3.4.1	Introduction.....	38
3.4.2	Procedures.....	38
3.5	Water Sorptivity .....	41
3.5.1	Intoduction .....	41
3.5.2	Apparatus .....	42
3.5.3	Procedure .....	42
3.5.4	Calculations.....	43
3.5.5	Factors that affect the sorptivity (ASTM C-1585) .....	44
3.6	Measurement of velocity of ultrasonic pulse in mortar.....	45
3.6.1	Introduction.....	45
3.6.2	Equipment .....	46
3.6.3	Procedure .....	46
3.6.4	Factors affect pulse velocity measurement (BS1881-203:1986).....	48
3.6.5	Correlations.....	49
CHAPTER 4 RESULTS AND DICUSSIONS .....		50
4.1	Strength .....	50
4.1.1	Outline .....	50
4.1.2	Early Strength Development of the Specimens.....	53
4.1.3	Later Strength Development of the specimens .....	57
4.1.4	Strength Activity Index .....	61
4.2	Sorptivity.....	64
4.2.1	Outline .....	64
4.2.2	The Effect of Curing Condition .....	64
4.2.3	The Effect of Cement Replacement Percentage .....	70
4.3	Pundit Result.....	73
4.3.1	Outline .....	73
4.3.2	The Growth in Pulse Velocity .....	73
4.3.3	Correlation of compressive strength and pulse velocity.....	80
4.3.4	Dynamic Modulus of Elasticity .....	84
CHAPTER 5 CONCLUSION AND RECOMMENDATIONS.....		86
5.1	Conclusions.....	86

5.2 Recommendations .....	88
REFERENCES .....	89
APPENDIX.....	91
APP1: Result of Compressive Strength .....	91
APP2: Result of sorptivity .....	92
APP3: Result of Pulse Velocity.....	93

# LIST OF FIGURES

FIGURE 2.1.1.1-THE EFFECT OF 23°C WATER CURE TO THE COMPRESSIVE STRENGTHS OF DIFFERENT MIX FORMULAS IN THE FIRST 30DAYS, (CAIJUN SHI, YANZHONG WU, CHRIS RIEFLER, & HUGH WANG, 2005).....	12
FIGURE 2.1.1.2- THE EFFECT OF 65°C WATER CURE TO THE COMPRESSIVE STRENGTHS OF DIFFERENT MIX FORMULAS IN THE FIRST 30DAYS, (CAIJUN SHI, YANZHONG WU, CHRIS RIEFLER, & HUGH WANG, 2005) .....	13
FIGURE 2.1.2.1-THE EFFECT OF 65°C WATER CURING TO THE STRENGTH ACTIVITY INDEX OF GLASS POWDER AND FLY ASH IN THE FIRST 28 DAY, (CAIJUN SHI, YANZHONG WU, CHRIS RIEFLER, & HUGH WANG, 2005) .....	14
FIGURE 2.1.2.2-THE EFFECT OF 65°C WATER CURING TO THE STRENGTH ACTIVITY INDEX OF GLASS POWDER AND FLY ASH IN THE FIRST 28 DAY, (CAIJUN SHI, YANZHONG WU, CHRIS RIEFLER, & HUGH WANG, 2005) .....	15
FIGURE 2.1.3.1-THE STRENGTH ACTIVITY INDEX OF THE SPECIMENS THAT CONTAIN DIFFERENT PERCENTAGES OF GLASS POWDERS AS A CEMENT REPLACEMENT MATERIAL, (PEREIRA-DE-OLIVEIRA, CASTRO-GOMES, & SANTOS, 2012) .....	17
FIGURE 2.1.3.1-THE EQUATION FOR SORPTIVITY (TASDEMIR, 2003) .....	18
FIGURE 2.2.1.1-GRADING TABLE OF GLASS POWDER THAT USED IN MATOS RESEARCH, (MATOS & SOUSA-COUTINHO, 2012) .....	20
FIGURE 2.2.1.2- GRADING TABLE OF GLASS POWDER THAT USED IN SCHWARZ RESEARCH, (SCHWARZ, CAM, & NEITHALATH, 2008) .....	20
FIGURE 2.2.1.3-THE SORPTIVITY OF MORTAR THAT CONTAIN DIFFERENT POZZOLANIC MATERIALS IN THE AGE OF 90, (MATOS & SOUSA-COUTINHO, 2012) .....	21
FIGURE 2.2.1.4-THE SORPTIVITY OF MORTAR THAT CONTAIN DIFFERENT POZZOLANIC MATERIALS IN THE AGE OF 90, (SCHWARZ, CAM, & NEITHALATH, 2008).....	21
FIGURE 2.2.2.1-SORPTIVITY OF AIR CURED SPECIMENS THAT CONTAIN DIFFERENT POZZOLANIC MATERIALS, (BAI, WILD, & SABIR, 2002).....	23
FIGURE 2.2.2.2- SORPTIVITY OF WATER CURED SPECIMENS THAT CONTAIN DIFFERENT POZZOLANIC MATERIALS, (BAI, WILD, & SABIR, 2002).....	23
FIGURE 2.3.1.1-THE DEVELOPMENT OF UPV OF SAMPLES THAT CURED IN WATER OF DIFFERENT TEMPERATURES IN THE FIRST 180 HOURS (YE, LURA, BREUGEL, & FRAAIJ, 2004).....	26
FIGURE 2.3.2.1-THE DEVELOPMENT OF ULTRASONIC PULSE VELOCITY OF SAMPLES THAT CONTAIN DIFFERENT PERCENTAGE OF SILICA FUME UNDER THE SAME CURING CONDITION IN THE FIRST 800MINUTES, (ZHANG, ZHANG, LIU, ZHANG, & LIU, 2012) .....	27



FIGURE 2.3.2.2-THE IDEA OF FILLER EFFECT, (ZHANG, ZHANG, LIU, ZHANG, & LIU, 2012)	28
FIGURE 2.3.3.1-CORRELATION OF PULSE VELOCITY AND COMPRESSIVE STRENGTH, (NASH'T, HAMEED, HAMEED, SADOON, & ABDULLAH, 2002)	29
FIGURE 3.4.2.1- ACCEPTABLE FORMS OF FAILURE AFTER COMPRESSION TEST, BS EN 12390-3	40
FIGURE 3.4.2.2- UNACCEPTABLE FORMS OF FAILURE AFTER COMPRESSION TEST, BS EN 12390-3	40
FIGURE 3.5.3.1 - DEMONSTRATION OF SORPTIVITY TEST, ASTM C-1585	43
FIGURE 3.5.4.1- A TYPICAL SORPTIVITY GRAPH, ASTM C-1585	44
FIGURE 3.6.1.1-DIRECT TRANSMISSION, BS1881	45
FIGURE 3.6.3.1-THE COUPLANT USED IN THIS PROJECT	47
FIGURE 3.6.3.2-THE SURFACE THAT WAS APPLIED WITH COUPLANT	48
FIGURE 4.1.1.1- THE EFFECT OF CURING CONDITIONS TO COMPRESSIVE STRENGTH OF SPECIMENS OF 0% CEMENT REPLACEMENT	51
FIGURE 4.1.1.2- THE EFFECT OF CURING CONDITIONS TO COMPRESSIVE STRENGTH OF SPECIMENS OF 20% CEMENT REPLACEMENT	51
FIGURE 4.1.1.3-THE EFFECT OF CURING CONDITIONS TO COMPRESSIVE STRENGTH OF SPECIMENS OF 40% CEMENT REPLACEMENT	52
FIGURE 4.1.1.4-THE EFFECT OF CURING CONDITIONS TO COMPRESSIVE STRENGTH OF SPECIMENS OF 0% CEMENT REPLACEMENT	52
FIGURE 4.1.2.1- THE EARLY COMPRESSIVE STRENGTH OF THE SAMPLES UNDER DIFFERENT CURING CONDITIONS: DAY3	55
FIGURE 4.1.2.2-THE EARLY COMPRESSIVE STRENGTH OF THE SAMPLES UNDER DIFFERENT CURING CONDITIONS: DAY7	55
FIGURE 4.1.2.3-THE RATIO OF STRENGTH OF THE SAMPLES CURED AT 60°C TO 27°C IN DAY3	56
FIGURE 4.1.2.4-THE RATIO OF STRENGTH OF THE SAMPLES CURED AT 60°C TO 27°C IN DAY7	56
FIGURE 4.1.3.1-THE COMPRESSIVE STRENGTH OF THE SAMPLES WITH DIFFERENT CEMENT REPLACEMENT PERCENTAGE IN DIFFERENT CURING CONDITIONS IN DAY60	59
FIGURE 4.1.3.2-THE RATIO OF STRENGTH OF THE SAMPLES THAT WERE CURED AT 60°C WATER TO 27°C WATER	60
FIGURE 4.1.3.3-THE RATIO OF DAY3 STRENGTH TO DAY60 STRENGTH	60
FIGURE 4.1.4.1- STRENGTH ACTIVITY INDEX OF SAMPLES WITH DIFFERENT CEMENT REPLACEMENT PERCENTAGE UNDER DIFFERENT CURING CONDITIONS	63
FIGURE 4.1.4.2-RELATIONSHIP OF STRENGTH ACTIVITY INDEX AND CEMENT	

REPLACEMENT PERCENTAGE .....	63
FIGURE 4.2.2.1- DIFFERENCES IN SORPTIVITY BETWEEN AIR CURED AND 60°C WATER CURE SAMPLE .....	66
FIGURE 4.2.2.2-SORPTIVITY OF SAMPLE THAT CONTAIN 0% GLASS POWDER AS CEMENT REPLACEMENT MATERIAL IN DIFFERENT CURING CONDITIONS.....	67
FIGURE 4.2.2.3-SORPTIVITY OF SAMPLE THAT CONTAIN 20% GLASS POWDER AS CEMENT REPLACEMENT MATERIAL IN DIFFERENT CURING CONDITIONS .....	67
FIGURE 4.2.2.4-SORPTIVITY OF SAMPLE THAT CONTAIN 40% GLASS POWDER AS CEMENT REPLACEMENT MATERIAL IN DIFFERENT CURING CONDITIONS .....	68
FIGURE 4.2.2.5-SORPTIVITY OF SAMPLE THAT CONTAIN 60% GLASS POWDER AS CEMENT REPLACEMENT MATERIAL IN DIFFERENT CURING CONDITIONS .....	68
FIGURE 4.2.2.6-THE REDUCTION OF SORPTIVITY OF SAMPLES OF DIFFERENT CEMENT REPLACEMENT PERCENTAGE UNDER DIFFERENT CURING CONDITIONS FROM DAY7 TO DAY60.....	69
FIGURE 4.2.2.7-SORPTIVITY OF SAMPLES IN DAY60 .....	69
FIGURE 4.3.2.1-PULSE VELOCITY OF SAMPLES WITH 0% GLASS POWDER AS CEMENT REPLACEMENT MATERIAL .....	76
FIGURE 4.3.2.2-PULSE VELOCITY OF SAMPLES WITH 20% GLASS POWDER AS CEMENT REPLACEMENT MATERIAL .....	76
FIGURE 4.3.2.3-PULSE VELOCITY OF SAMPLES WITH 40% GLASS POWDER AS CEMENT REPLACEMENT MATERIAL .....	77
FIGURE 4.3.2.4-PULSE VELOCITY OF SAMPLES WITH 60% GLASS POWDER AS CEMENT REPLACEMENT MATERIAL .....	77
FIGURE 4.3.2.5-PULSE VELOCITY OF AIR CURED SAMPLES.....	79
FIGURE 4.3.2.6-PULSE VELOCITY OF 27°C WATER CURED SAMPLES .....	79
FIGURE 4.3.2.7-PULSE VELOCITY OF 27°C WATER CURED SAMPLES .....	80
FIGURE 4.3.3.1-RELATIONSHIP BETWEEN COMPRESSIVE STRENGTH AND PULSE VELOCITY .....	82
FIGURE 4.3.3.2-COMPRESSIVE STRENGTH AGAINST PULSE VELOCITY (ONLY SAMPLE OF 0%CEMENT REPLACEMENT WERE USED) .....	82
FIGURE 4.3.3.3-COMPRESSIVE STRENGTH AGAINST PULSE VELOCITY (ONLY SAMPLE OF 20%CEMENT REPLACEMENT WERE USED) .....	83
FIGURE 4.3.3.4-COMPRESSIVE STRENGTH AGAINST PULSE VELOCITY (ONLY SAMPLE OF 40%CEMENT REPLACEMENT WERE USED) .....	83
FIGURE 4.3.3.5-COMPRESSIVE STRENGTH AGAINST PULSE VELOCITY (ONLY SAMPLE OF 60%CEMENT REPLACEMENT WERE USED) .....	84
FIGURE 4.3.4.1-DYNAMIC MODULUS OF ELASTICITY IN DAY 60.....	85

## **LIST OF TABLES**

TABLE 2.3.3.1-MIX DESIGN FOR THIS CURRENT PROJECT .....	30
TABLE 2.3.3.2-GRADING OF GLASS POWDER .....	30
TABLE 3.6.4.1-THE EFFECT OF TEMPERATURE ON PULSE TRANSMISSION AND THE RESPECTIVE CORRECTIONS .....	49

## **LIST OF PHOTOGRAPHS**

PICTURE 2.3.3.1-THE MOLDS WERE COVERED BY PLASTIC SHEETS.....	37
PICTURE 2.3.3.2-TEMPERATURE CONTROL UNIT OF THE WATER TANKS.....	37
PICTURE 3.4.2.1-INSIDE OF A COMPRESSIVE STRENGTH TEST MACHINE.....	39
PICTURE 3.4.2.2- A RECORD OF FAILURE FORM OF A SPECIMEN AFTER COMPRESSION TEST.....	39

## **LIST OF EQUATIONS**

EQUATION 2.3.1-DEVELOPMENT OF UPV IN THE FIRST 1200 MINUTES, (ZHANG, ZHANG, LIU, ZHANG, & LIU, 2012).....	25
EQUATION 3.5.1-THE EQUATION OF ABSORPTION, ASTM C-1585 .....	43
EQUATION 3.6.1-EQUATION OF PULSE VELOCITY .....	47
EQUATION 3.6.2-THE CORRELATION OF PULSE VELOCITY WITH DYNAMIC MODULUS OF ELASTICITY .....	49

# CHAPTER 1 INTRODUCTION

## 1.1 Background

Glass powder has every potentials to be utilized as a pozzolanic material. The idea of using glass powder as a pozzolanic material has emerged since the early 70s (M. Pattengil, 1973), but most of the progressions on this idea were considered recent.

Waste glass are produced from time to time, only in Hong Kong 245tons of waste glasses are disposed per day, which caused a huge burden to the capacity of landfills. Recently, the waste glass levy has been suggested by HKEPD to encourage the reduction and promote the reclamation of waste glass. According to EPD, it is expected to retrieve about 70% of the total waste glass in the near future. As a result of the future abundance of recycled waste glass, the researches about the applications and behaviors of this pozzolanic material were vigorously encouraged.

Pozzolanic materials such as silica fume and fly ash, have already been widely used to replace cement to reduce production cost and improve the properties of concrete. Considered also the potential economic value of pozzolanic material, the researches of the possibility of applying waste glass as a pozzolanic material were again encouraged.

Effort have been made to investigate the influences of using different curing conditions to improve the behavior of the specimens (Caijun Shi, YanZhong Wu, Chris Riefler, & Hugh Wang, 2005). Water cured samples usually could provide a better performance in most of the characteristic of concrete than air cured samples. Many

researchers have also revealed the same idea, which validated that curing condition is a factor that affect the performance of the concrete.

This paper presents a study on the characteristic of the samples that contain waste glass as cement replacement material. In hopes that this research could possibly produce a useful reference for the proprietors in the construction industry to consider the possibilities of using waste glass. A series of test were done to study the mentioned aims; the compressive strength tests were done to investigate the strength development; the PUNITS tests were done to investigate the dynamic modulus of elasticity and correlation of strength; the sorptivity tests were conducted to reveal the performance in regard of durability.

## **1.2 Objective**

The objective of the project in question is to provide a useful reference to the construction industry to consider the application of glass powder as a pozzolanic material. Compressive Strength, Durability and Pulse Velocity have been investigated in this research as a result of the importance of these characteristics.

## **1.3 Outline**

Chapter 1, Introduction, a brief description about this project in question was shown in this part

Chapter 2, Literature Review, the reviewed literatures were introduced in this part. Prior to the discussion of results, the literatures could provide a preliminary idea of the entire research. This part was important, as it could help the readers to cultivate an appropriate sense of judgment and understanding to the topic

Chapter 3, Method and Material, the detail procedures of the experiments conducted in this research were described to provide a clear standard for readers to follow.

Chapter 4, Result and Discussion, the result were mentioned and commented in this section.

Chapter 5, Conclusion and Recommendation, the findings and some follow up recommendations for this project were mentioned in this section as a closing.

# CHAPTER 2 LITERATURE REVIEW

## 2.1 Strength

The two factors which contribute to the compressive strength of the cement replacement mortar were the hydration of cement and the pozzolanic activity of the glass powder, so more study of these two topics are required. The following questions will be investigated to provide an adequate judgment and understanding on this aspect.

2.1.1 How curing temperature does affects the hydration of cement?

2.1.2 How curing temperature does affects the pozzolanic activity of the glass powder?

2.1.3 How does the replacement percentage affect the compressive strength growth in the same curing temperature? How does the fineness of the glass powder affect the compressive strength?

### **2.1.1 The effects of water curing of different temperatures toward the compressive strength of the plain cement mortars**

**High water temperature curing could improve the early strength, but not the later strength of the specimens.**

According to the findings of Shi, 2005, it is observed that although high water curing temperature have a conducive effect on enhancing the compressive strength in the early age, i.e. Day3, a deleterious effect would occur in later age.

The respective results are shown in figure 2.1.1.1 and 2.1.1.2, where important points were arrowed in red. When the water curing temperature was raised from 23°C to 65°C, the 7-day strengths for the Portland Cement (PC) Mix was simultaneously

increased to 24 from 29MPa, which was about an increment of 18%. However, when the water curing age was longer, the effect of high water temperature curing is deleterious to the compressive strength. The 28-day strength were decreased from 35 to 26 MPa, when the water curing temperature increase from 23°C to 65°C.

The same deleterious effect of high water temperature curing was also seen in another research (Ezziane, Bougara, Kadri, H.Khelafi, & E.Kadri, 2007). **According to the same research, this effect is known as the ‘Crossover Effect’**. As the temperature rise, the reaction products are forced to form themselves in a quicker manner, but such acceleration would interrupt the process. As a result of the reaction products do not have sufficient time to distribute uniformly and nicely within the pores of the cement, the later strength will decrease. Although high curing temperature could accelerate the growth of early strength, the final strength would have to be sacrificed.

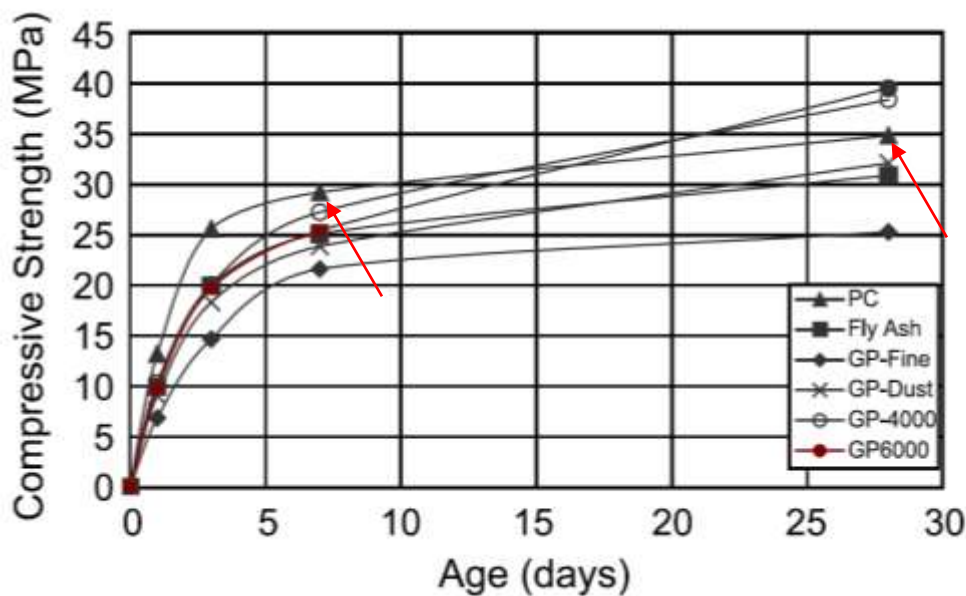

Figure 2.1.1.1-The effect of 23°C water cure to the Compressive strengths of different mix formulas in the first 30days, (Caijun Shi, YanZhong Wu, Chris Riefler, & Hugh Wang, 2005)



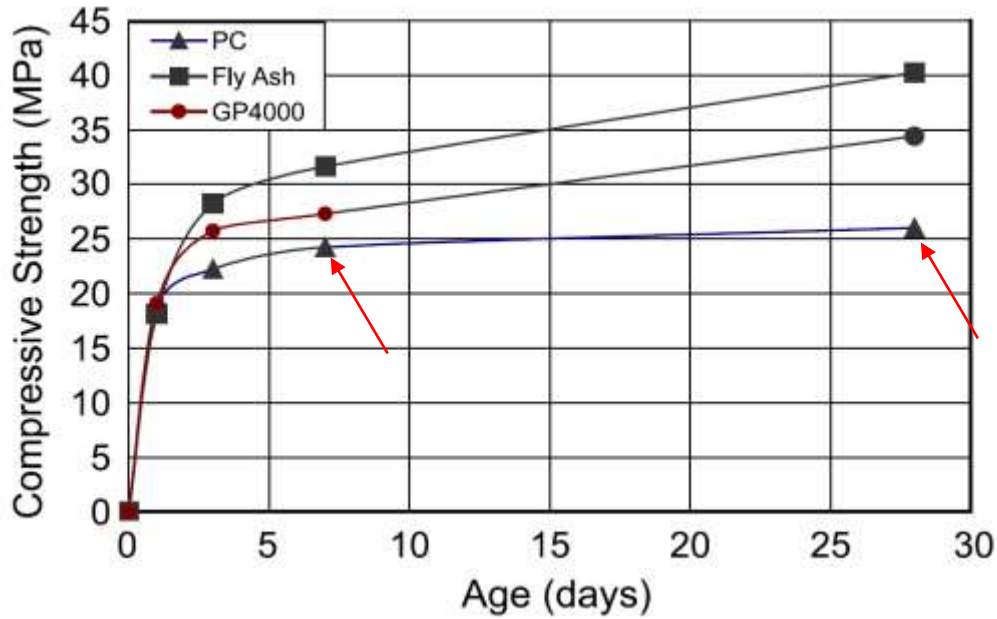

Figure 2.1.1.2- The effect of 65°C water cure to the Compressive strengths of different mix formulas in the first 30days, (Caijun Shi, YanZhong Wu, Chris Riefler, & Hugh Wang, 2005)

## 2.1.2 The effect of curing temperature of water on the pozzolanic activity of the glass powder

**High temperature water curing is conducive to the Strength Activity Index, which indicate the pozzolanic activity.** (Caijun Shi, YanZhong Wu, Chris Riefler, & Hugh Wang, 2005)

In figure 2.1.2.1 and 2.1.2.2 of the same research showed the strength activity index of the samples, which contain 20% of different pozzolanic materials as a replacement of cement, in different water curing temperatures. The important points were arrowed in red. GP4000 is a glass powder which has a similar distribution to the Portland cement. For day one, the strength activity index for GP4000 were 79% and 102% for the samples which is cured at 23°C water and 65°C water respectively. For the days 28, the strength reactivity index is 110% and 130% for the samples which is cured at 23°C water and 65°C water respectively. This phenomenon was explained by

SHI, 2005 that a higher activation energy is needed for the reaction between glass powder and lime than that of the hydration of cement. In other words higher water curing temperature is conducive to the pozzolanic activity of glass powder.

However, this mentioned research has only investigated the sample that contain 20% glass powder as a replacement of cement. This is certainly not comprehensive enough to reveal the whole situation, further study will be required to determine whether samples that contain higher cement replacement percentage could, too, achieve a satisfying strength activity index by curing at high temperature water.

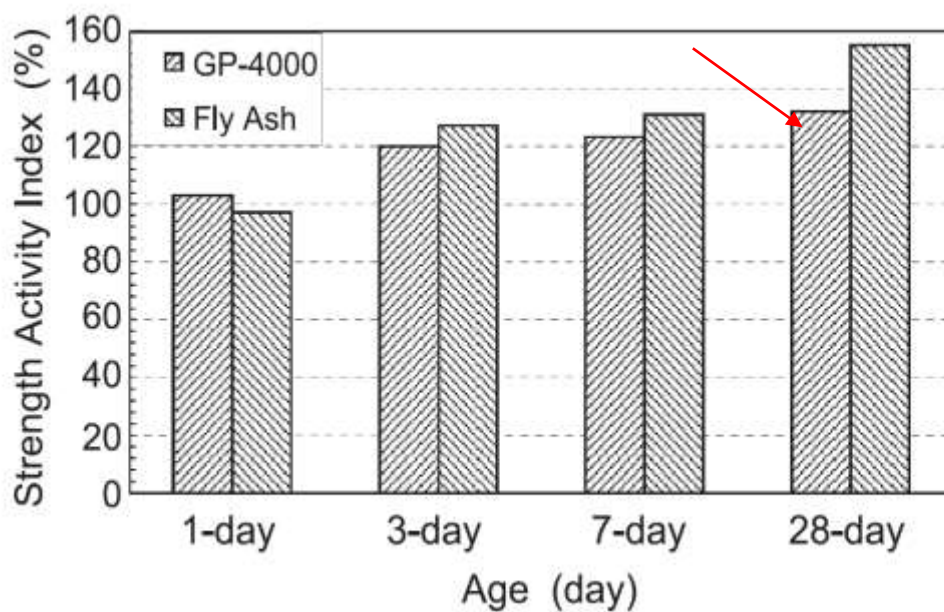

Figure 2.1.2.1-The effect of 65°C water curing to the strength activity index of glass powder and fly ash in the first 28 day, (Caijun Shi, YanZhong Wu, Chris Riefler, & Hugh Wang, 2005)

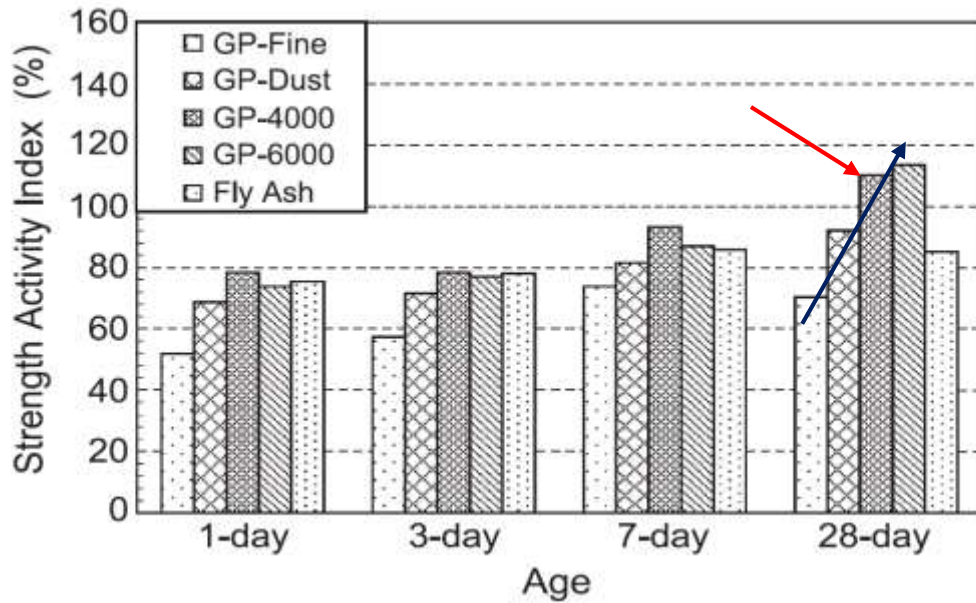

Figure 2.1.2.2-The effect of 65°C water curing to the strength activity index of glass powder and fly ash in the first 28 day, (Caijun Shi, YanZhong Wu, Chris Riefler, & Hugh Wang, 2005)

### 2.1.3 The effect of cement replacement percentage and fineness on compressive strength of cement mortar

**Finer glass powder could provide a better result in regard of strength, while higher cement replacement percentage would give a lower compressive strength** (Pereira-de-Oliveira, Castro-Gomes, & Santos, 2012). The researchers of this paper have used the glass powders of different colors and sizes, such as amber, green, flint, 0-45 $\mu$ m 45-75 $\mu$ m and 75-150 $\mu$ m respectively, so this research has shown a comprehensive idea that how the cement replacement percentage and the fineness of glass powder would affect the characteristic of the specimens.

#### i. The effect of replacement Percentage

**A higher replacement percentage could produce a lower strength activity index and vice versa.** For example in Figure 2.1.3.1, for the sample that contained 75-150 $\mu$ m amber glass powder, the strength activity index drop gradually when the

replacement percentage increase, i.e. the strength activity index reduced from 100% to 55% when the cement replacement percentage increase from 0% to 40%.

**However, in some occasions the strength activity index will increase to a maximum prior to its drop when the cement replacement percentage increase.**

Refer to figure 2.1.3.1, for the samples that contain 0-45 $\mu$ m amber glass powder where their trend line are shown in red, the strength activity index first increase to a little over 100% when the replacement percentage is 10%, and then it drop with the increase of the cement replacement percentage.

More than that, it is interesting that the **colors of the glass powders could produce a difference in regard of strength activity index**. For example, the samples that contained the same percentage of amber and green glass powder of the same size could be different in strength activity index for 15%. However, the author did not explain this phenomenon.

## ii. The effect of Fineness of the glass powder

**A finer glass powder could increase the strength activity index of the samples as much as 40%.** For example, the 90-day strength activity index of the samples that contain 40% of amber glass powder of different size, namely 0-45 and 75-150 $\mu$ m, as cement replacement were 92% and 55% respectively. This is about a difference of 40%. After obtaining this result, the author of that paper concluded that the fineness of glass powder is one of the fundamental parameter to determine the reactivity of the pozzolanic reaction.

Furthermore, the same idea was also suggested by other research, such as (Caijun Shi, YanZhong Wu, Chris Riefler, & Hugh Wang, 2005). The glass powders that were used in SHI, WU, RIEDLER and WANG are listed according to their ascending

fineness: GP- Fine, GP-Dust, GP-4000, and GP-6000. Refer to figure 2.1.2.2, the strength activity index of the samples which contain glass powders increase when the fineness of the glass powders increases-see the blue arrow.

However, the researches that are done outside Hong Kong could not provide a comprehensive reference for Hong Kong, as the weather and the glass type are different in every locations. As a result of the mentioned uncertainty, more local studies are needed to reveal the specific behaviors of using glass powder as a pozzolanic material in Hong Kong.

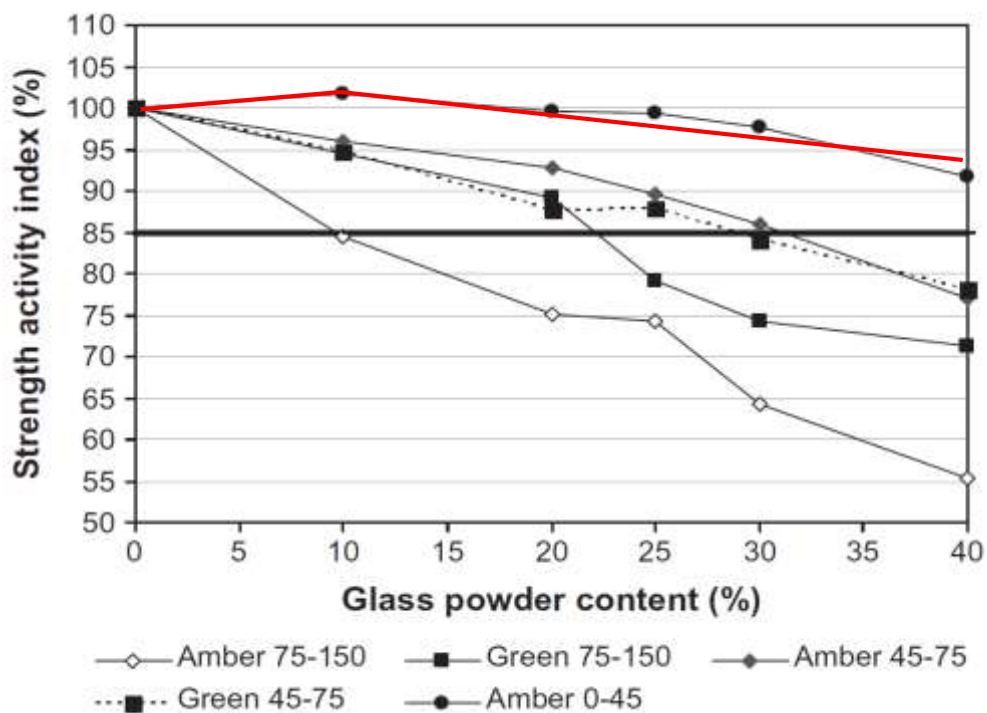

Figure 2.1.3.1-The strength activity index of the specimens that contain different percentages of glass powders as a cement replacement material, (Pereira-de-Oliveira, Castro-Gomes, & Santos, 2012)

## 2.2 Sorptivity

Sorptivity is an important parameter that determine the concrete characteristic when it is exposed to an aggressive environment, such as underwater. Sorptivity present the ability of the material to absorb and transmit water through it by capillary suction, so sorptivity is also called capillary suction (Pitroda & Umrigar, 2013). This ability is governed by surface tension acting on the capillaries, so the pore structure which are radius, tortuosity and continuity of capillaries indeed would create differences on the results. A higher sorptivity implies that the samples are more prone to absorb water by capillary action. The sorptivity is given by the equation below:

$$\frac{Q}{A} = k\sqrt{t}$$

where  $Q$  = the amount of water adsorbed in ( $\text{cm}^3$ );  $A$  = the cross section of specimen that was in contact with water ( $\text{cm}^2$ );  $t$  = time (s);  $k$  = the sorptivity coefficient of the specimen ( $\text{cm/s}^{1/2}$ ).

Figure 2.1.3.1-The equation for sorptivity (Tasdemir, 2003)

### 2.2.1 The effect of replacing cement by glass powder of different fineness and percentage to the sorptivity of the specimens

#### **A finer glass powder could produce a lower sorptivity.**

This idea will be shown by comparing two similar research, they are (Matos & Sousa-Coutinho, 2012) and (Schwarz, Cam, & Neithalath, 2008). They both took part in investigating the sorptivity of the samples which have contain glass powder as a cement replacement material. The detail grading table of the glass powder that Matos and Schwarz used are shown in figure 2.2.1.1 and 2.2.1.2 respectively. It could be seen

that the glass powder that Matos used was in a comparable size with cement, while those used by Schwarz were of a larger size.

In figure 2.2.1.3 and 2.2.1.4 showed the sorptivity of the samples with different pozzolanic material in age 90. In Matos's experiment, the sorptivity of the sample that contain 10% glass powder was the same as the control, which is  $0.047(\text{mm}/\text{t}^{0.5})$ ; while in Schwarz's experiment, the sorptivity of the sample that contain 10% glass powder was  $0.06(\text{mm}/\text{t}^{0.5})$ , which is higher than the control.

The lower sorptivity of the finer glass powder samples is explained by Matos & Sousa by distribution of the glass powder, as when the glass powder has a distribution similar to the cement, the capillary pores of the specimen are similar to the control.

**The increase of replacement percentage of glass powder in cement mortar would not bring a significant difference on the sorptivity.** (Matos & Sousa-Coutinho, 2012) It is seen on figure 2.2.1.3, the sorptivity of the specimens of 10% (WGP10) and 20% (WGP20) cement replacement were  $0.047(\text{mm}/\text{t}^{0.5})$  and  $0.048(\text{mm}/\text{t}^{0.5})$  respectively. They only differ by  $0.001(\text{mm}/\text{t}^{0.5})$ . However, this research only include the replacement percentage to 20% which probably could not represent the situation when the cement replacement percentage is higher

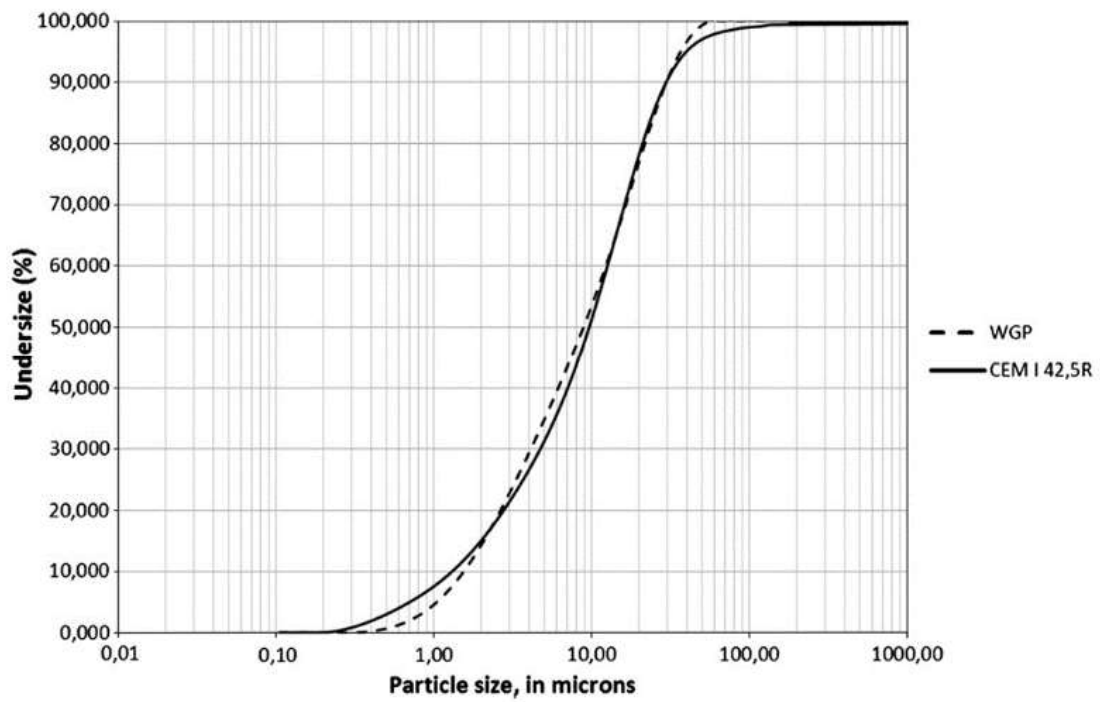

Figure 2.2.1.1-Grading table of glass powder that used in Matos research, (Matos & Sousa-Coutinho, 2012)

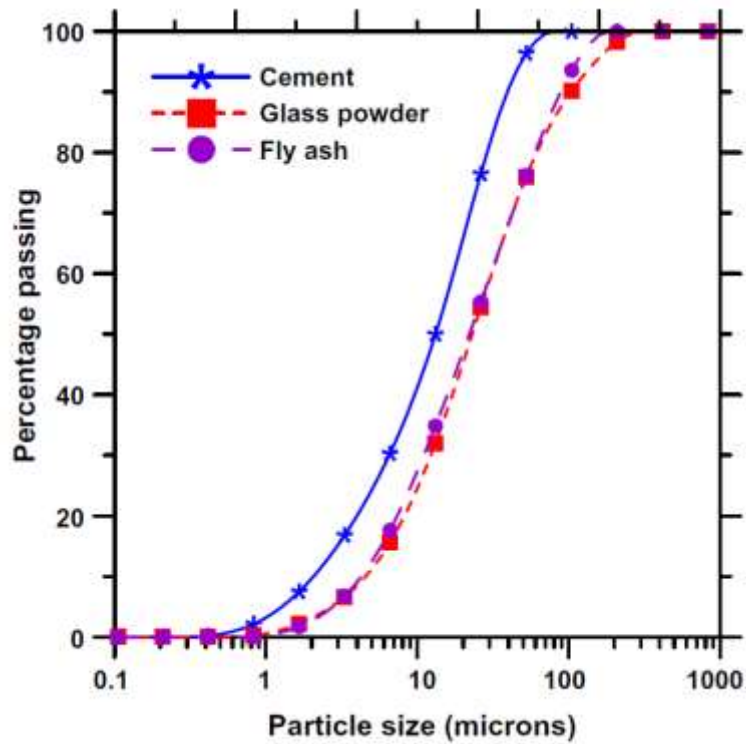

Figure 2.2.1.2- Grading table of glass powder that used in Schwarz research, (Schwarz, Cam, & Neithalath, 2008)



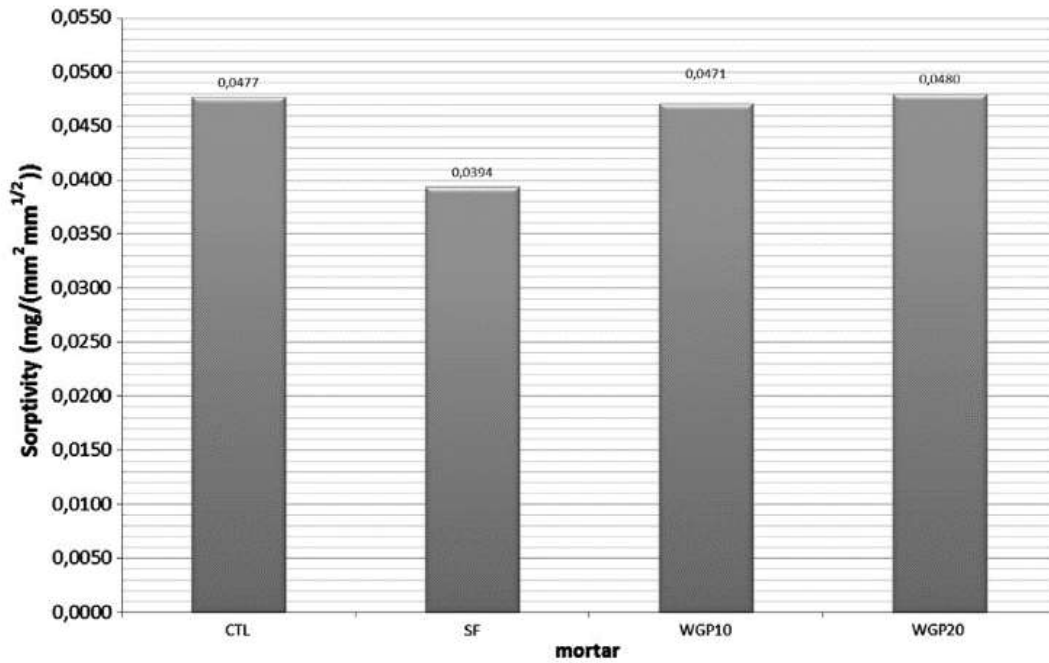

Figure 2.2.1.3-The sorptivity of mortar that contain different pozzolanic materials in the age of 90, (Matos & Sousa-Coutinho, 2012)

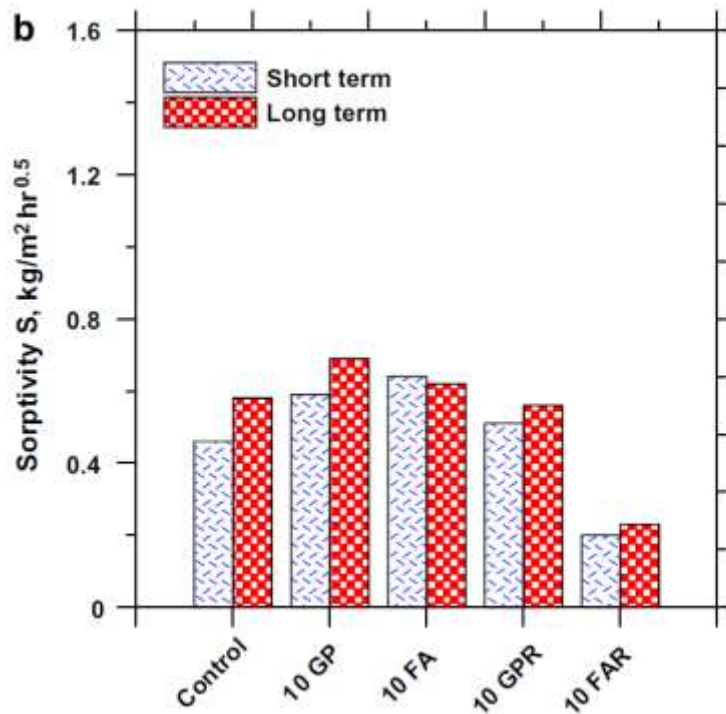

Figure 2.2.1.4-The sorptivity of mortar that contain different pozzolanic materials in the age of 90, (Schwarz, Cam, & Neithalath, 2008)

## **2.2.2 The effect of different curing conditions to the sorptivity of the plain cement mortar**

**Samples that were cured by air generally exhibit a higher sorptivity than those were cured by water.**

According to figure 2.2.2.1 and 2.2.2.2, where important points were arrowed in red, from (Bai, Wild, & Sabir, 2002), the sorptivity of the specimens that cured by air and water were  $0.28(\text{g}/\text{mm}^2/\text{min}^{0.5})$  and  $0.2(\text{g}/\text{mm}^2/\text{min}^{0.5})$ . The water cured samples essentially exhibit a lower, which is better, sorptivity than that cured by air. The researchers had explained this by the reduction in level of hydration on the surface layer of the air cured specimen. It is believed that the same phenomenon would be expected in the cement mortar that contain glass powder too, as the hydration mechanism is similar. It is possible to conclude that, curing mediums, such as air and water, would affect the sorptivity. However, whether the sorptivity is affected by water curing temperature is still uncertain.

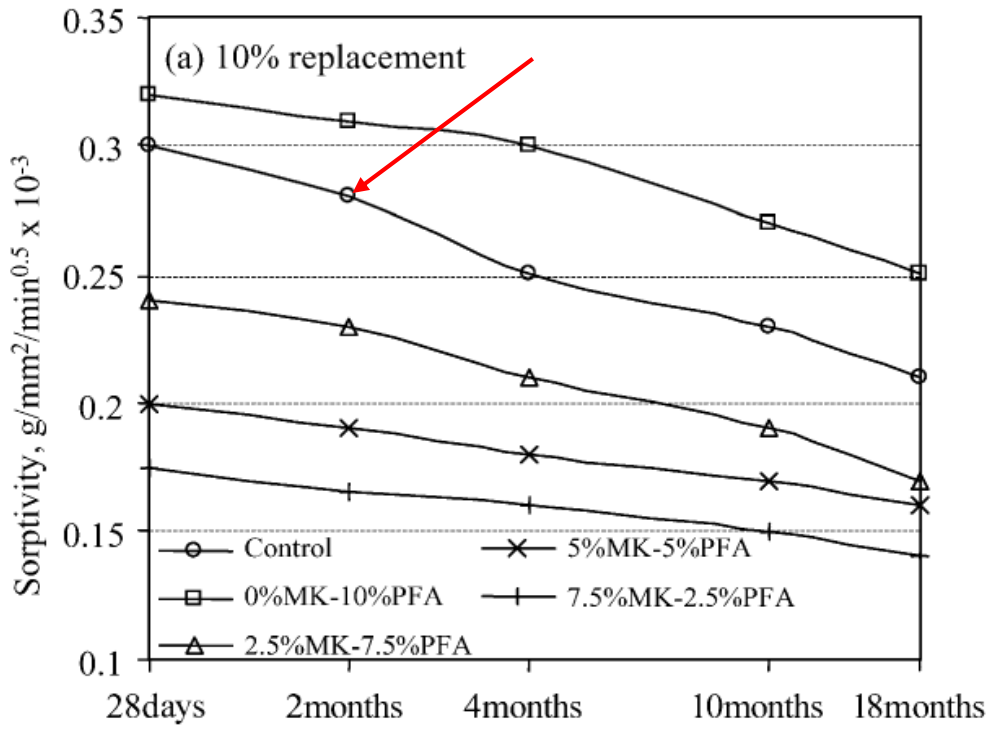

Figure 2.2.2.1-Sorptivity of air cured specimens that contain different pozzolanic materials, (Bai, Wild, & Sabir, 2002)

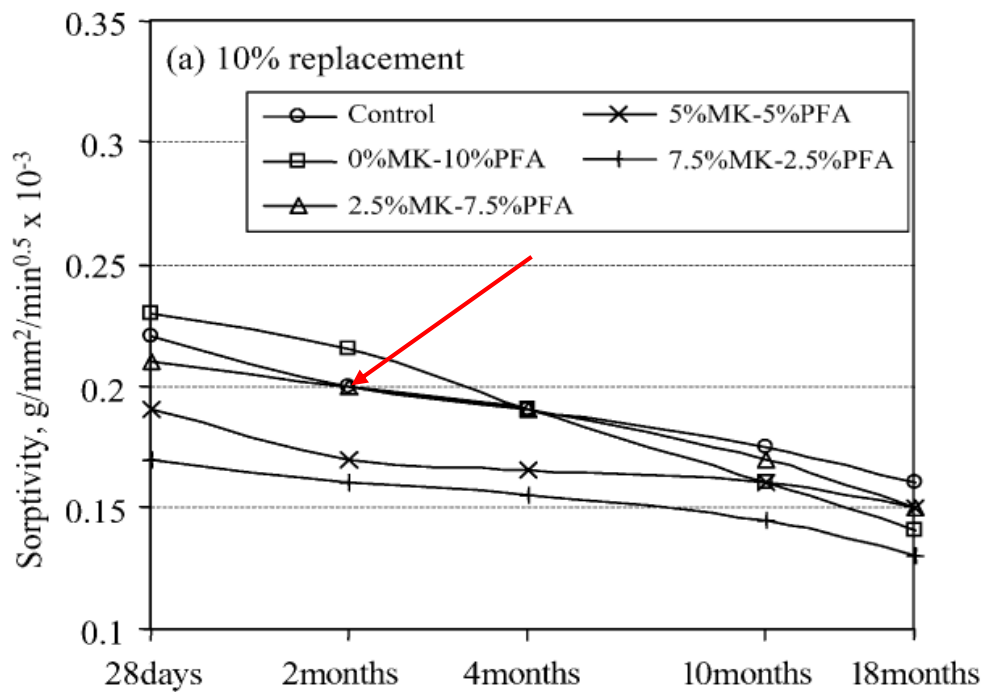
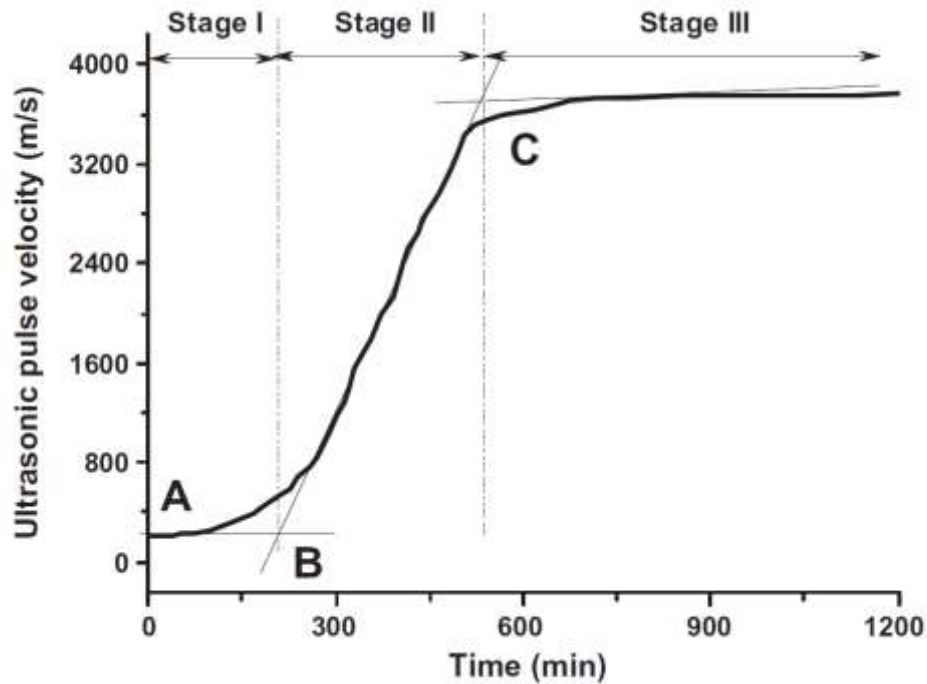

Figure 2.2.2.2- Sorptivity of water cured specimens that contain different pozzolanic materials, (Bai, Wild, & Sabir, 2002)

## 2.3 Pulse Velocity

PUNDITS is a test that utilize ultrasonic sound wave and the result is obtained by measuring the pulse velocity, which could reveals the apparent strength and detect the voids in that material. The PUNDITS result is affect by number of parameters, such as elastic stiffness and the mechanical strength of the sample etc.... Therefore, the result of PUNDIT is difficult to interpret

There are three main stages in the UPV curve which is the result of the ultrasonic test. They are 1) dormant stage, 2) acceleration stage and 3) deceleration stage (Zhang, Zhang, Liu, Zhang, & Liu, 2012). In the first stage, the cement paste are essentially a water-like viscous suspension, which is not good at transmitting pulse, but this stage only continue for a short period of time; for the second stage, the cement particles start to connect together by cement hydration at a rapid pace, so the pulse start to gain speed quickly; for stage three, essentially all the cement particles are connected together already, so the growth in velocity is minimal. The first two stage usually happen in the first day after the specimen was made and the third stage will continue to infinity from Point C, see figure 2.3.1.



Equation 2.3.1-Development of UPV in the first 1200 minutes, (Zhang, Zhang, Liu, Zhang, & Liu, 2012)

### 2.3.1 The effect of different curing conditions to the pulse velocity of plain cement mortar

High temperature water curing could help the samples to arrive to STAGE 3 earlier. The pulse velocity is also observed to be higher in STAGE 3 when the specimens were cure at high water temperature. (Ye, Lura, Breugel, & Fraaij, 2004). For the detail, please refer to figure 2.3.1.1, which showed the influences of different water curing temperature to pulse velocity of the specimens in the first 180 hours. According to Ye, Lura, Breugel and Fraaij, this is explained by the accelerated hydration process in the specimen under high temperature, as high temperature assist the production of hydration products, which provide a solid path sooner for the pulse to travel through.

However, the research (Ye, Lura, Breugel, & Fraaij, 2004), only shows the early stage of the development of UPV curve, while the influence of high temperature curing

on UPV on later stage, such as 28 days and 60days, is unknown. More researches have to be done, as a result of the unknown.

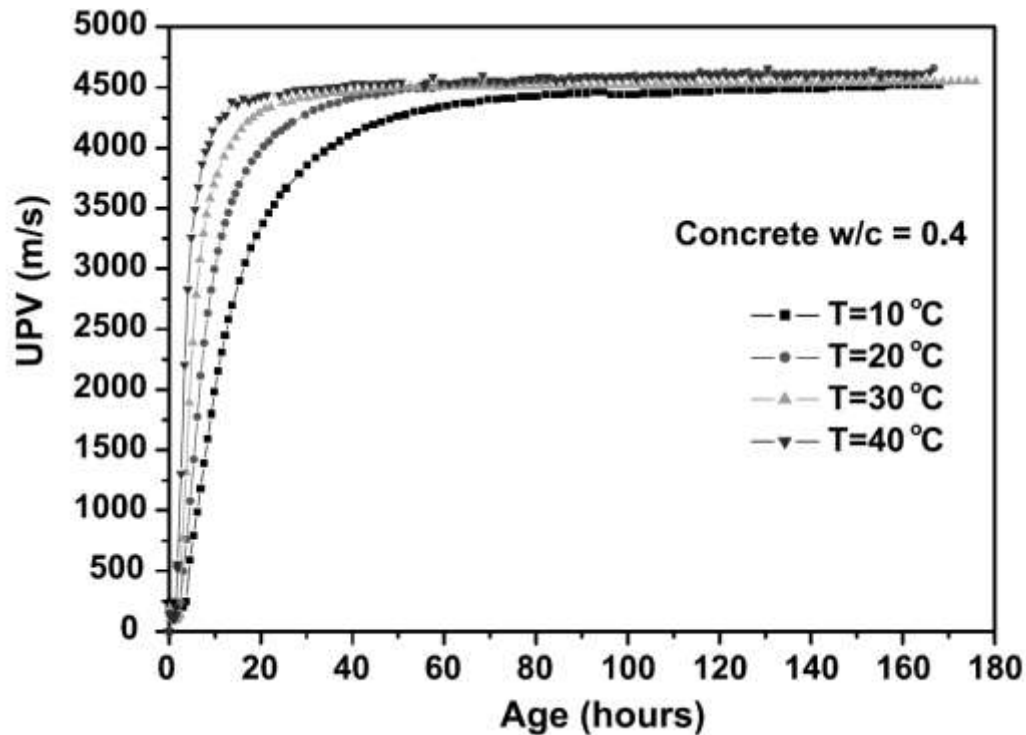

Figure 2.3.1.1-The development of UPV of samples that cured in water of different temperatures in the first 180 hours (Ye, Lura, Breugel, & Fraaij, 2004)

### 2.3.2 The effect of applying pozzolanic material to replace cement in regards of pulse velocity

**It is found that replacing cement with some pozzolanic material could help the specimens to achieve a higher ultrasonic pulse velocity faster.** (Zhang, Zhang, Liu, Zhang, & Liu, 2012)

This research that is done by Zhang who aims to investigate the behavior of the specimens with silica fume. Refer to figure 2.3.2.1, it could be seen that clearly the pulse velocity increase more rapidly when the cement replacement percentage increase. The same discovery were also found by other researcher, such as (H & S., 1980) and

(MW, SD, & DM, 1983). The reasons that the above researchers have mentioned for the above observations will be introduced in the following. Firstly, the surface area of silica fume is high, which make it highly reactive; this characteristic of silica fume help the cement to hydrate faster. Secondly, silica fume could undergo a dissolution in Ca(OH)<sub>2</sub> in a short period of time and form a layer, which connect the particles and provide a solid percolation path for the pulse to pass through. This could also help the sample to gain pulse velocity faster. Thirdly, the silica fume fill up more space between cement particles, so less hydration product of cement is needed to connect the particles together. This idea is called the filler effect and is showed in Figure2.3.2.2.

However, the case for glass powder replacement is probably different, as the size of glass powder is significantly larger than silica fume and the reactivity of glass powder to Ca(OH)<sub>2</sub> is different too.

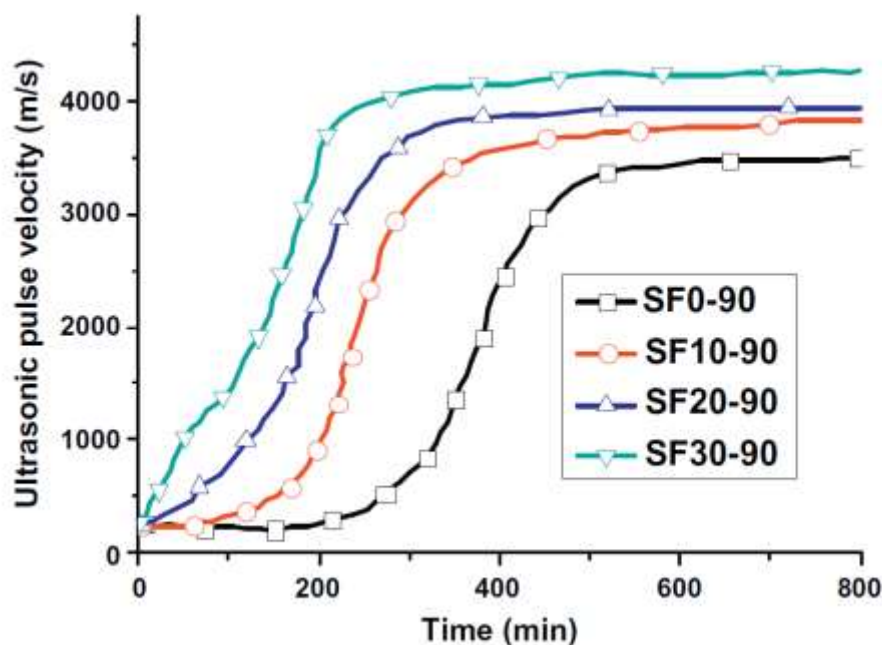

Figure 2.3.2.1-The development of ultrasonic pulse velocity of samples that contain different percentage of silica fume under the same curing condition in the first 800minutes, (Zhang, Zhang, Liu, Zhang, & Liu, 2012)

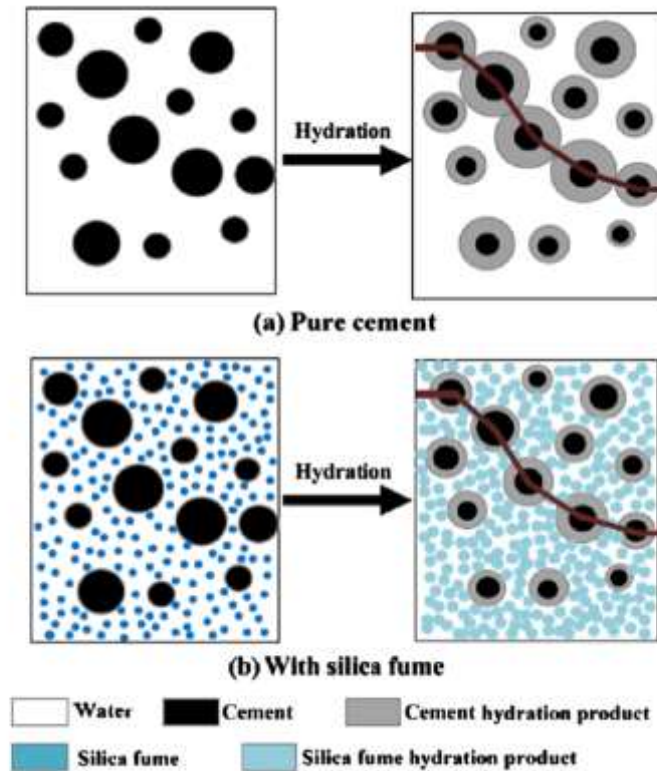

Figure 2.3.2.2-The idea of filler effect, (Zhang, Zhang, Liu, Zhang, & Liu, 2012)

### 2.3.3 The relationship between Pulse velocity and compressive strength

**There numerous of ways to correlate pulse velocity with the compressive strength, such as using artificial network and simple equation.**

(Trtnik, Kavcic, & Turk, 2009) Turk, Kavcic and Trtnik is one of the research teams that adopt artificial network to correlate the compressive strength and pulse velocity. As the correlation of strength with pulse velocity involves many parameters, where a simple analyzing tool could not fully show the relation. It is believed that this is the trend of correlating strength with pulse velocity.

Another way is that the researches use some less complicated mathematics to correlate the two parameters. The following equation is the result of one of the research team. (Nash't, Hameed, Hameed, Sadoon, & Abdullah, 2002)



$$S_c = 1.19 \text{ EXP } 0.715U$$

Where,  $S_c$  = compressive strength (MPa)

$U$  = Ultrasonic Pulse Velocity (km/sec)

Figure 2.3.3.1-Correlation of pulse velocity and compressive strength, (Nash't, Hameed, Hameed, Sadoon, & Abdullah, 2002)

## 2.4 Pozzolanic Reaction of Glass Powder

The compressive strength of the cement replacement mortar are contributed by two reactions, namely **primary cement hydration** and **secondary pozzolanic reaction**.

The equation of the secondary reaction is as follow:



## CHAPTER 3 METHOD AND MATERIAL

### 3.1 Mixing Design and testing Schedule

168 samples of four different mixes which contained different percent of glass powder as cement replacement material were used. The cement replacement percentage included (0%, 20%, 40% and 60%). The samples were divided evenly into three groups of equal numbers and cured in different curing conditions respectively, namely Air, 27°C water and 65°C water. The samples participated in the following tests in different ages: compression strength test, water sorptivity test and PUNDITS. For compressive test and water sorptivity test, this research offer the data of day 3, 7, 28 and 60; while for PUNDITS this research offer the result of 7,28 and 60.

The mix design were shown on table 3.1.1. The w/c ratio was 0.47 for all samples. The glass powder used was smaller than 300µm, where the detail grading were shown in table 3.1.2, while the fine aggregate was smaller than 2.36mm.



<b>Mix Design</b>					
<u>Replacement Percentage</u>	<u>Cement (kg)</u>	<u>Glass Powder &lt;300µm (kg)</u>	<u>Fine Aggregate &lt;2.36mm (kg)</u>	<u>Water (kg)</u>	<u>W/C</u>
0%	16.41	0	48.20	7.72	0.47
20%	12.74	3.67	48.20	7.72	0.47
40%	9.56	6.85	48.20	7.72	0.47
60%	6.37	10.04	48.20	7.72	0.47

Table 2.3.3.1-Mix Design for this current project



<b>Grading of glass powder</b>		
<u>Passing (sieve size)</u>	<u>Retained on (sieve size)</u>	<u>Weight (%)</u>
300µm	150µm	32.60%
150µm	-	67.40%



Table 2.3.3.2-Grading of glass powder



### 3.2 Material and apparatus

<b>Materials</b>		
<b>Numbers</b>	<b>Descriptions</b>	<b>Photos</b>
1	Portland Cement	
2	Glass Powder	

3	Fine Aggregate	
4	Water	

<b>Apparatus</b>		
<b>Numbers</b>	<b>Descriptions</b>	<b>Photos</b>
1	Mixing Machine	
2	Molds	

3	Water-Cooling Saw	 A photograph of a water-cooling saw, also known as a diamond saw. The machine is primarily green and orange. It features a large circular blade mounted on a vertical frame. A blue apron is hanging from the side of the machine. The saw is positioned on a concrete floor in a workshop or laboratory setting.
4	Compressive strength Testing Machine	 A photograph of a compressive strength testing machine. The machine is a large, industrial-grade piece of equipment with a white and blue color scheme. It has a control panel on the front with a digital display and various buttons. The machine is situated in a laboratory or testing facility.

5	Tray for Sorptivity Test	
6	Pundits Tester	
7	Water Tank	

### 3.3 Mixing and Curing

The process of sampling and curing were done in accordance with BS EN 12390-2 to ensure the quality of the specimens. The cubes dimension were 100mm<sup>3</sup>.

#### Procedures:

- i. Inspect and oil the mold.

The molds were screwed and applied with releasing agent, which facilitate the de-molding process afterwards.

- ii. Mix the mortar.

The mortar was mix with the mixing machine.

- iii. Fill the mold with the mortar and compaction.

The mortar were filled in three layers and followed by three subsequent compactions; their purposes were to reduce the voids.

- iv. Curing of specimens.

The mortar were exposed to air after they were casted for a day. During this period, the molds were covered with thin plastic sheets –see figure 3.3.1, as the humidity was low that day. This measure is to prevent the rapid loss of water inside the mortar, which would cause the mortar to set badly.

After the first day, the specimens were then dismantled from the molds and exposed to respective curing conditions, such as Air, 27°C water and 60° water. These curing treatments were done in accordance with BS EN 12390-2.

In picture 3.3.2, the heating control unit of the water tank was shown. It is used to maintain the water in the tank in a desire temperature.





Picture 2.3.3.1-The molds were covered by plastic sheets



Picture 2.3.3.2-Temperature control unit of the water tanks

## **3.4 Compressive strength**

### **3.4.1 Introduction**

Compressive strength is an important parameter that define the quality of a concrete. There are a few methods to identify the compressive strength of the concrete, but only direct compression test will be discussed here. In order to obtain the data which is measured under the same standard with other researches, BS EN 12390-3 is followed in this research.

### **3.4.2 Procedures**

- i. Enter the required compression rate.

According to BS EN 12390-3, the compression rate for 100mm<sup>3</sup> cubes was 0.6 MPa/s, so the loading rate for the specimen of 100mm<sup>3</sup> was 0.6KN/s.

- ii. Place the cube into the designated location. See picture 3.4.2.1

- iii. Record the result.

This machine operate automatically, when you place the specimen onto the testing area, the machine will complete all the work. The result will be in the unit of MPa.

- iv. Check the result

Only the result of the samples which failed in acceptable forms could be used. Figure 3.4.2.1 and 3.4.2.2 showed the acceptable and unacceptable forms of failure after compression test. Picture 3.4.2.1 showed a failure form of a specimen after compression test



Picture 3.4.2.1-Inside of a compressive strength test machine



Picture 3.4.2.2- A record of failure form of a specimen after compression test

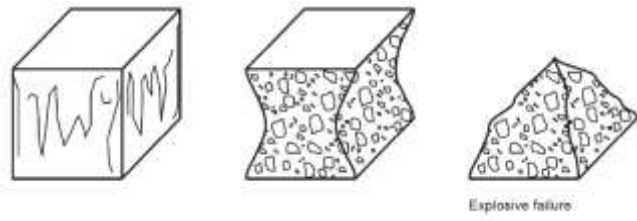
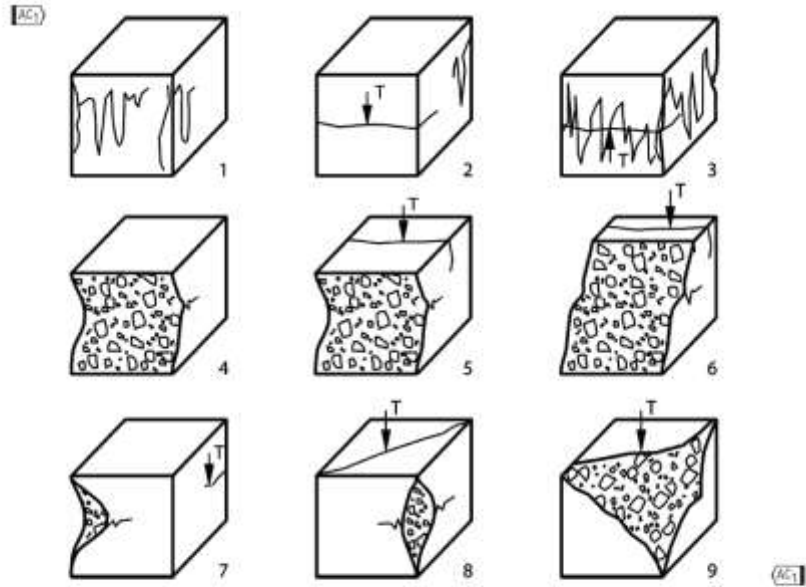

Figure 3.4.2.1- Acceptable forms of failure after compression test, BS EN 12390-3



NOTE T = tensile crack

Figure 3.4.2.2- Unacceptable forms of failure after compression test, BS EN 12390-3

## 3.5 Water Sorptivity

### 3.5.1 Introduction

This test aims to reveal the durability of the specimens. Water sorptivity could reflect the characteristic of concrete or mortar, when they are exposed to adverse environment, such as under sea. The principle of sorptivity test is measure the increment of weight of the sample due to water absorption by capillary action.

There are two kind of sorptivity; they are initial absorption and secondary absorption. Initial absorption use the weight data from 1min to 6hours, whereas the secondary sorptivity use the data from 1 day to 7 days. However, only initial absorption is investigated in this research.

The procedure of sorptivity test in this research essentially follows the standard ASTM C-1585, as to provide consistency for other researches. However, please notice the following differences:

- i. Shape of the samples,

In this research the dimension of the samples were 50x100x100mm(H,L,W);  
the square surface was used to absorb water

- ii. The sampling condition.

The sample were dried in oven for 24 hours.

### **3.5.2 Apparatus**

- i. A Tray
- ii. A Support Device
- iii. A Top-pan Balance
- iv. A Timing Device
- v. A Cloth
- vi. A Water-Cooled Saw
- vii. A Caliper

### **3.5.3 Procedure**

- i. The Specimens were cut into half by a water-cool saw.
- ii. Dried the sample in the oven for 24 hours and cool it for the next 24 hours
- iii. Set up the testing tray with compliance with figure 3.5.4.1
- iv. Filled the pan with water; the water level should be 2mm higher than the specimen support
- v. Weighed the initial mass of the sample
- vi. Placed the specimen on the support and ready the timer
- vii. The specimens were weighed at the following time, 5,10,30,60 and 120 mins after the specimens were placed on the support. The result must be recorded within 15s after the samples were taken out of water and the samples should return immediately to the water after measurement.

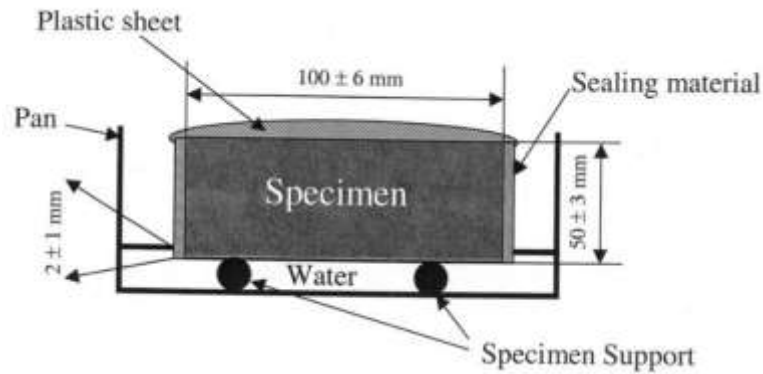

Figure 3.5.3.1 - Demonstration of Sorptivity test, ASTM C-1585

### 3.5.4 Calculations

After obtained the weight of the samples, a graph of Absorption( $I$ ) against Square root of time (minutes<sup>0.5</sup>) was plotted; an example was shown in figure 3.5.5.2. Absorption( $I$ ) could be obtained by using equation 3.5.5.1. Then the sorptivity of the specimen was obtained by finding the slope of the best fit line of the previously plotted graph.

$$I = \frac{m_t}{a \cdot d}, \quad (1)$$

where:

- $I$  = the absorption,
- $m_t$  = the change in specimen mass in grams, at the time  $t$ ,
- $a$  = the exposed area of the specimen, in mm<sup>2</sup>, and
- $d$  = the density of the water in g/mm<sup>3</sup>.

Equation 3.5.1-The equation of absorption, ASTM C-1585

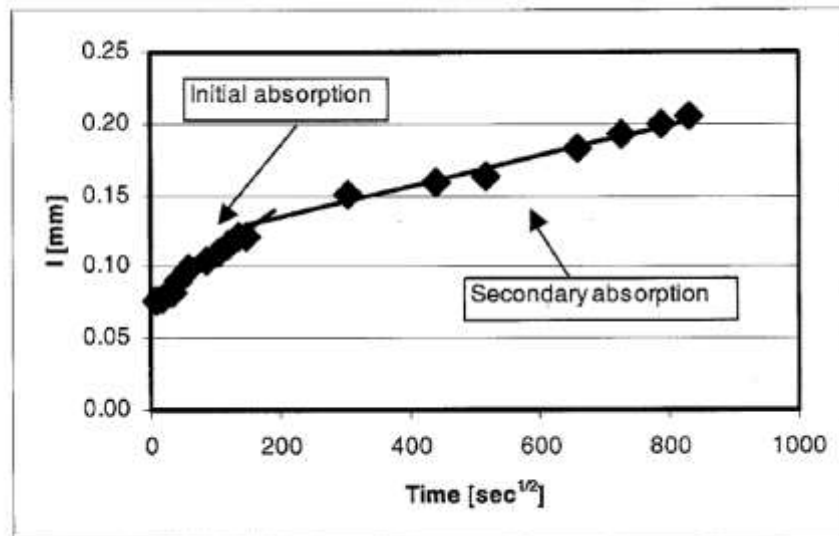

Figure 3.5.4.1- A typical sorptivity graph, ASTM C-1585

### 3.5.5 Factors that affect the sorptivity (ASTM C-1585)

- i. Concrete mixture proportions
- ii. The presence of chemical admixtures and supplementary cementitious materials
- iii. The composition and physical characteristics of the cementitious component and of the aggregates
- iv. The entrained air content
- v. Type and duration of curing
- vi. Age of the sample
- vii. The present of microcrack
- viii. Surface treatment
- ix. Placement method, e.g. compaction, placing sequence



## 3.6 Measurement of velocity of ultrasonic pulse in mortar

### 3.6.1 Introduction

The PUNDITS tests in this research were done in accordance with BS 1881-203:1986. The reason of executing the experiments according to the standard in question was to unify the result with other researches and allow the results to be discussed on the same ground.

Ultrasonic testing has been used in different places to measure the qualities of the concrete or other materials, but BS1881 only focus on concrete. There are three kinds of test that could be done by the PUNDITS equipment, including direct, semi-direct and indirect transmission test, to provide a different result of different meanings. However, only the detail of direct transmission –see figure 3.6.1.1 –will be discussed, as the project in question only has direct transmission involved.

Direct Transmission Test make use of two separate transducers, which attached to the sample oppositely, to calculate the time that the ultrasonic pulse required to go across the sample. In this research the path length of the samples were 100mm, so the pulse velocity could be calculated by dividing the path length (km) with time(s).

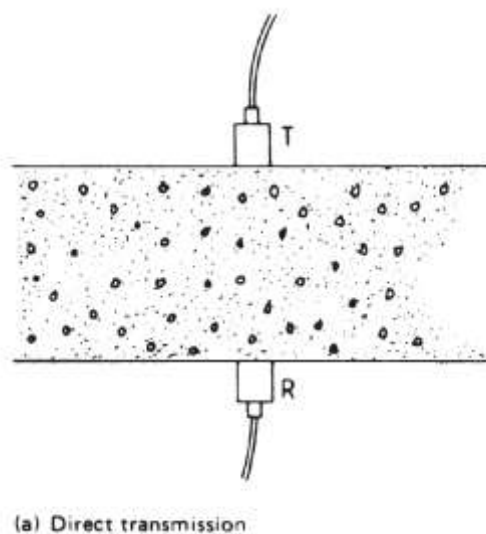

Figure 3.6.1.1-Direct Transmission, BS1881

### 3.6.2 Equipment

There were a few apparatus that involved in the test, namely, an electrical pulse generator, a pair of transducer, amplifier and an electronic timing device. The Pulse Generator take up the role of generating ultrasonic pulse; the amplifier is to strength the pulse; the transducer is to transmit and receive the pulse; at last the electronic timing device is used to measure the time that the ultrasonic pulse travel across the specimens. To ensure the accuracy, the equipment were inspected and calibrated every time before use. The set of equipment used in this research were shown in section 3.2

### 3.6.3 Procedure

- i. Calibrate the timing device.

The set of equipment were calibrated by using a standard tube, which would provide a standard 26 $\mu$ s result. If the result deviate from 26 $\mu$ s, the timing device could be adjusted accordingly.

- ii. Effectively couple the transducer onto the specimen.

The target surfaces of the specimen which receive the transducers could be any opposite two faces, but only not the troweled face, as the troweled face could not be as smooth as the others. More than that, before placing the transducers into position, couplant has to be applied on that particular surface to receive the transducer, as to provide a smoother surface which would provide more accurate results. The couplant could be petroleum jelly, grease etc..., they will serve the same purpose. The couplant used in this research was shown in picture

iii. Record the result.

The result could be read directly on the screen of the equipment. To improve the accuracy, the transducers were placed on two different locations to provide two results, as such action could further avoid the odds that the result would reflect the situation when the pulse passes a void.

The result were in the unit of (km/s), the equation for the calculations was shown in equation 3.6.3.1

The pulse velocity  $v$  (in km/s or m/s) is given by

$$v = \frac{L}{T}$$

where

$L$  is the path length;

$T$  is the time taken by the pulse to traverse that length.

Equation 3.6.1-Equation of pulse velocity



Figure 3.6.3.1-The couplant used in this project



Figure 3.6.3.2-The surface that was applied with couplant

### 3.6.4 Factors affect pulse velocity measurement (BS1881-203:1986)

i. Water content.

The curing condition and the free water in the voids would affect the pulse velocity

ii. The testing temperature

There are respective adjustments for the result, when the specimen temperature are different. Table 3.6.4.1 has shown the correction to the measured pulse velocity. However, the experiments done in this project were conducted in normal ambient temperature, no adjustments were made.

iii. The size of aggregate

The required path length of the specimen which their aggregates are smaller than 20mm is 100mm.

**Effect of temperature on pulse transmission**

Temperature	Correction to the measured pulse velocity	
	Air-dried concrete	Water-saturated concrete
°C	%	%
60	+ 5	+ 4
40	+ 2	+ 1.7
20	0	0
0	- 0.5	- 1
- 4	- 1.5	- 7.5

Table 3.6.4.1-The effect of temperature on pulse transmission and the respective corrections

### 3.6.5 Correlations

Non-destructive test is popular, as there are a few parameters that the pulse velocity could correlate with, including Modulus of Elasticity, Strength and porosity. They are all important factors that decide the quality of the concrete. However, the accuracy of the correlations were not at their optimum, as there are too many factors that affect the pulse velocity. The correlation of dynamic modulus of elasticity is in the following:

- i. Dynamic Modulus of Elasticity

$$E_d = \rho v^2 \frac{(1 + \nu)(1 - 2\nu)}{(1 - \nu)}$$

where

$E_d$  is the dynamic elastic modulus (in MN/m<sup>2</sup>);

$\nu$  is the dynamic Poisson's ratio;

$\rho$  is the density (in kg/m<sup>3</sup>);

$v$  is the pulse velocity (in km/s).

Equation 3.6.2-The correlation of pulse velocity with dynamic modulus of elasticity

# CHAPTER 4 RESULTS AND DICUSSIONS

## 4.1 Strength

### 4.1.1 Outline

The samples with cement replacement still exhibit a general behavior which the specimens gain compressive strength when they age. The graphs that reveal the strength gain were plotted in figure 4.1.1.1 to 4.1.1.4. This finding is, indeed, expected in any research on the same topic, so not much paragraphs were spent to explain this phenomenon. Other than the general observation, the result were analyzed in numbers of ways to provide comprehensive ideas that how cement mortar with different cement replacement percentage would behave in different curing conditions. The following ideas were investigated:

- i. Early strength development of the specimens
- ii. Later strength development of the specimens
- iii. Strength activity index
- iv. Relationship between cement replacement percentage and strength

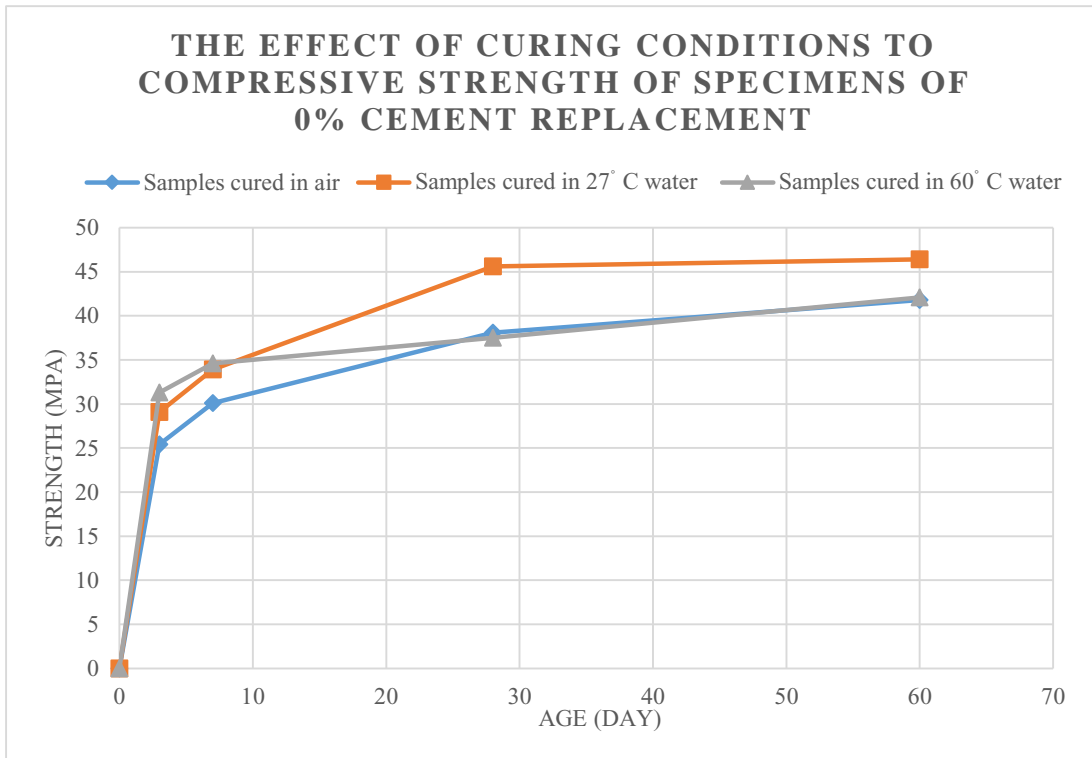

Figure 4.1.1.1- The effect of curing conditions to compressive strength of specimens of 0% cement replacement

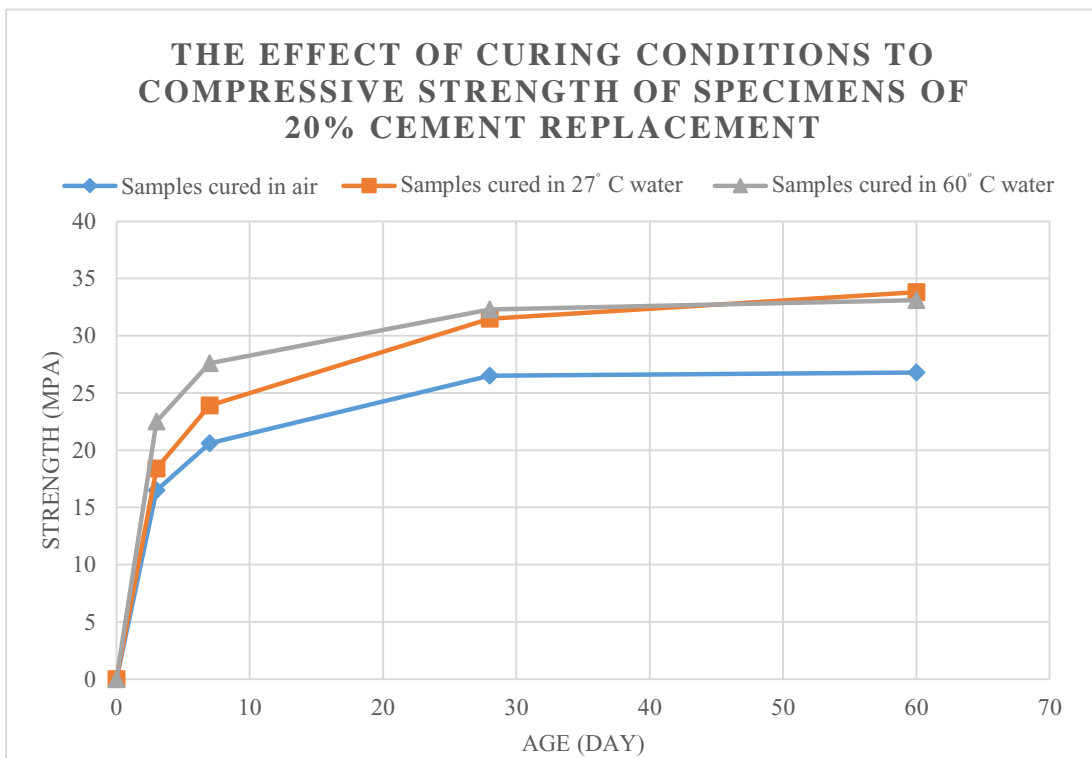

Figure 4.1.1.2- The effect of curing conditions to compressive strength of specimens of 20% cement replacement

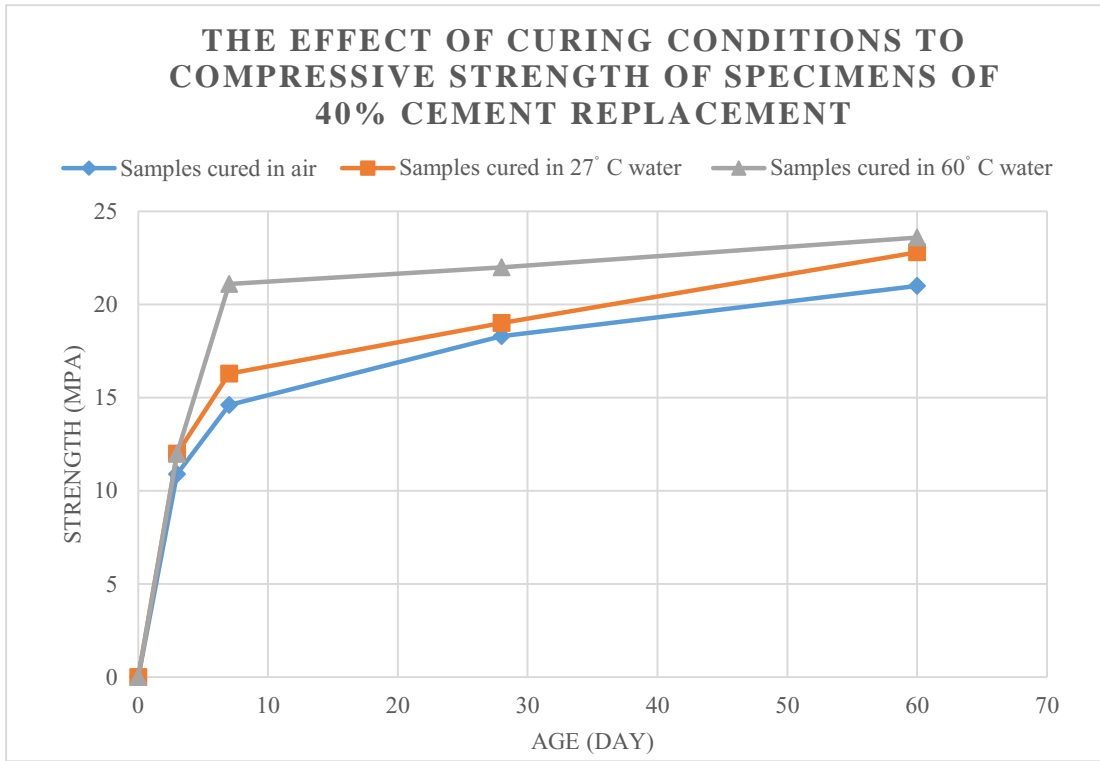

Figure 4.1.1.3-The effect of curing conditions to compressive strength of specimens of 40% cement replacement

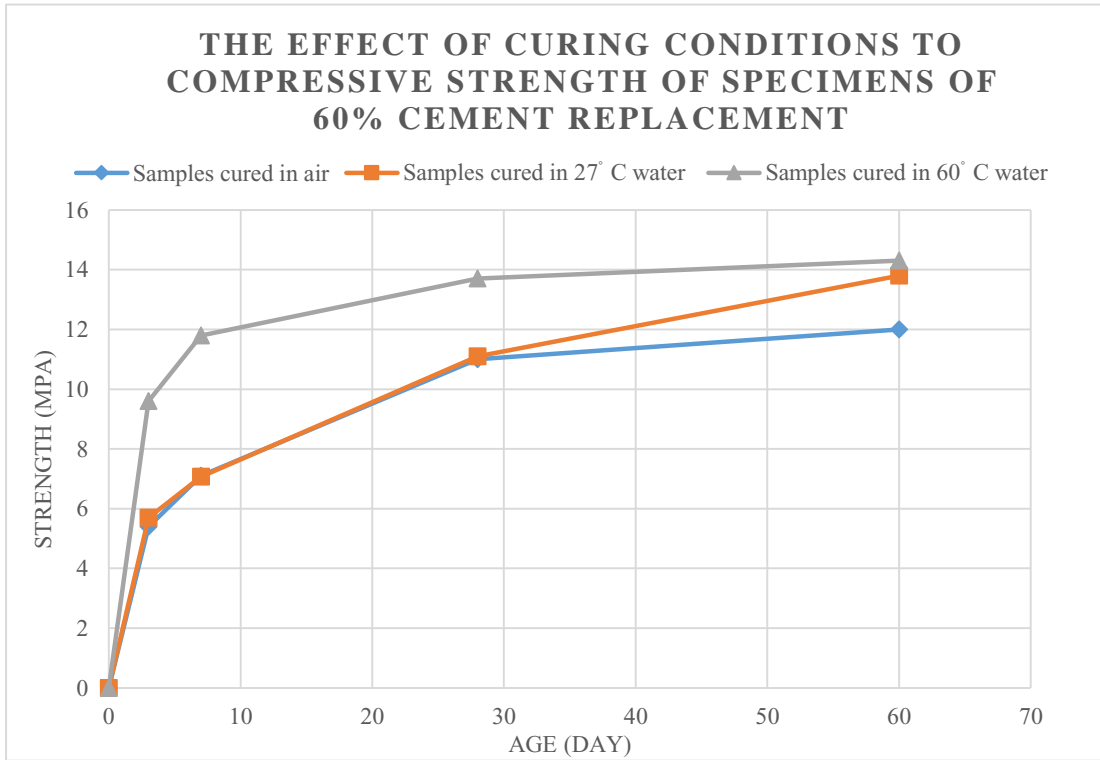

Figure 4.1.1.4-The effect of curing conditions to compressive strength of specimens of 0% cement replacement



### 4.1.2 Early Strength Development of the Specimens

Early strength of a concrete could affect the construction process very much, such as the time before striking the formwork or the time it takes before the concrete could support itself. As a result, some sentences were spent to talk about this property of the cement replacement mortar.

**The strength differences in early age between the samples which were cured at 60 ° C and 27 ° C water were larger for those samples that contain more glass powder as cement replacement material.** Figure 4.1.2.1 to 4.1.2.2 show the actual strength in (MPa) of the specimen, while Figure 4.1.2.3 to 4.1.2.4 show the ratio of strength of the specimens which are cured at 60°C water to that of 27°C water. These figures could effectively reveal the trend of strength in different curing condition and cement replacement percentage. At day3, 60°C water curing has improved the early strength to 108%, 122%, 135% and 168% to that of the specimen which were cured at 27°C water respectively for the sample of 0%, 20%, 40% and 60% cement replacement; While at day 7, 60°C water curing has improved the early strength by 102%, 115%, 129% and 167% to that of the specimen which were cured at 27°C water respectively for the sample of 0%, 20%, 40% and 60% cement replacement.

The reason for the just mentioned large difference in strength was that the glass powder is more sensitive than cement to high water temperature where they could acquire themselves with more energy to finish the pozzolanic reactions (Caijun Shi, YanZhong Wu, Chris Riefler, & Hugh Wang, 2005). As a result of the higher sensitivity of glass to high water temperature, when there were more glass powder in the sample, the strength increment in percentage between the samples cured in 60°C water and 27°C water was more significant.

**The early strength of the sample decreased when the cement replacement percentage was increased,** take the samples that were cured in 60°C water as an example, the compressive strength were 31.3, 22.5, 12 and 9.6 Mpa in day3 and 34.6, 27.6, 21.1 and 11.8 Mpa in day7 for the samples that contain 0%, 20%, 40% and 60% cement replacement. It could be observed that in figure 4.1.2.3-4.1.2.4 the compressive strength decreased while the cement replacement parentage increased.

It seems that the effect of the pozzolanic reaction was not comparable to the hydration of cement, so the early compressive strength of the samples decreased with the increased of glass powder. This weak pozzolanic reaction was probably contributed by the large glass powder size – smaller than 300  $\mu\text{m}$ . As according to (Shao, Lefort, Moras, & Rodriguez, 2000) only glass powder with the size smaller than 38 $\mu\text{m}$  exhibits a significant pozzolanic behavior and improve the strength. Another reason is probably the cement hydration product produced was not enough for the pozzolanic reaction to occur as much as the samples with lower cement replacement percentage.

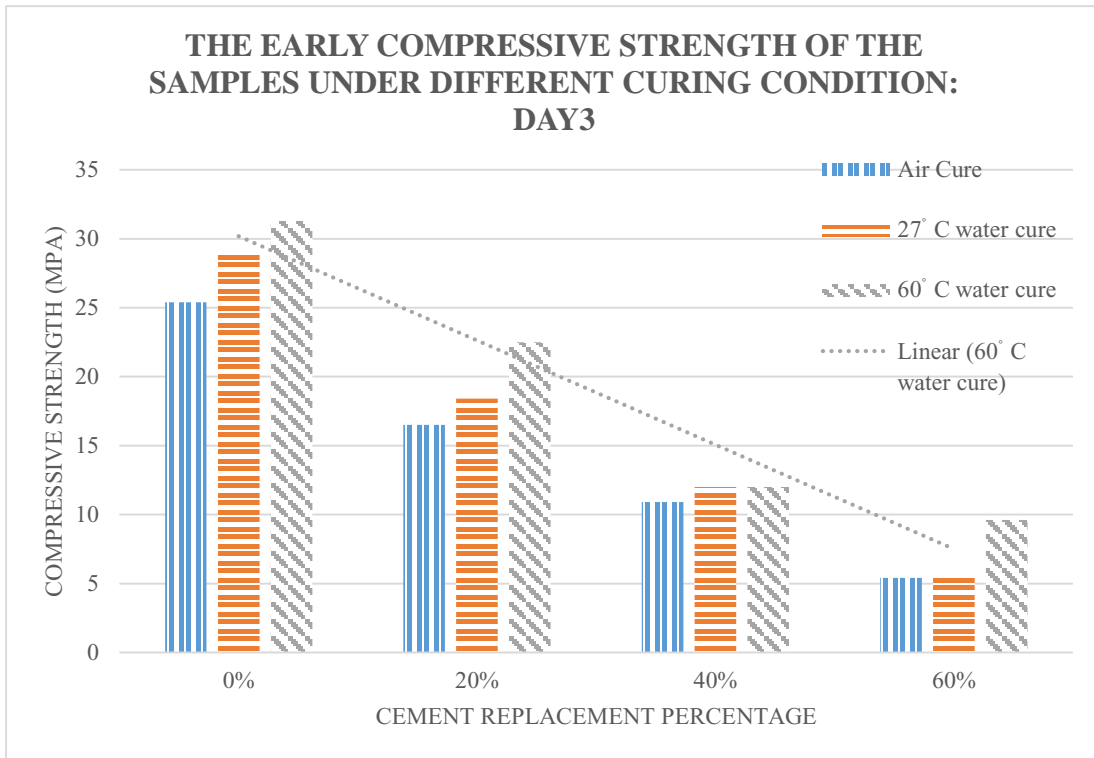

Figure 4.1.2.1- The early compressive strength of the samples under different curing conditions: day3

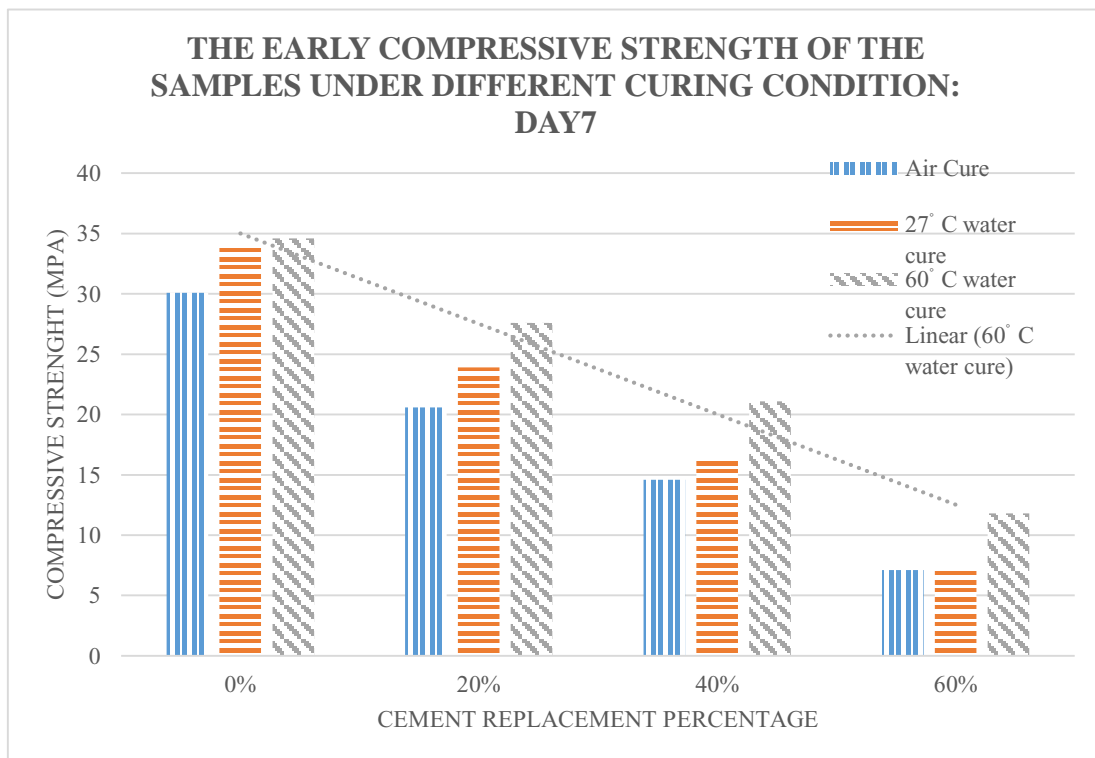

Figure 4.1.2.2-The early compressive strength of the samples under different curing conditions: day7

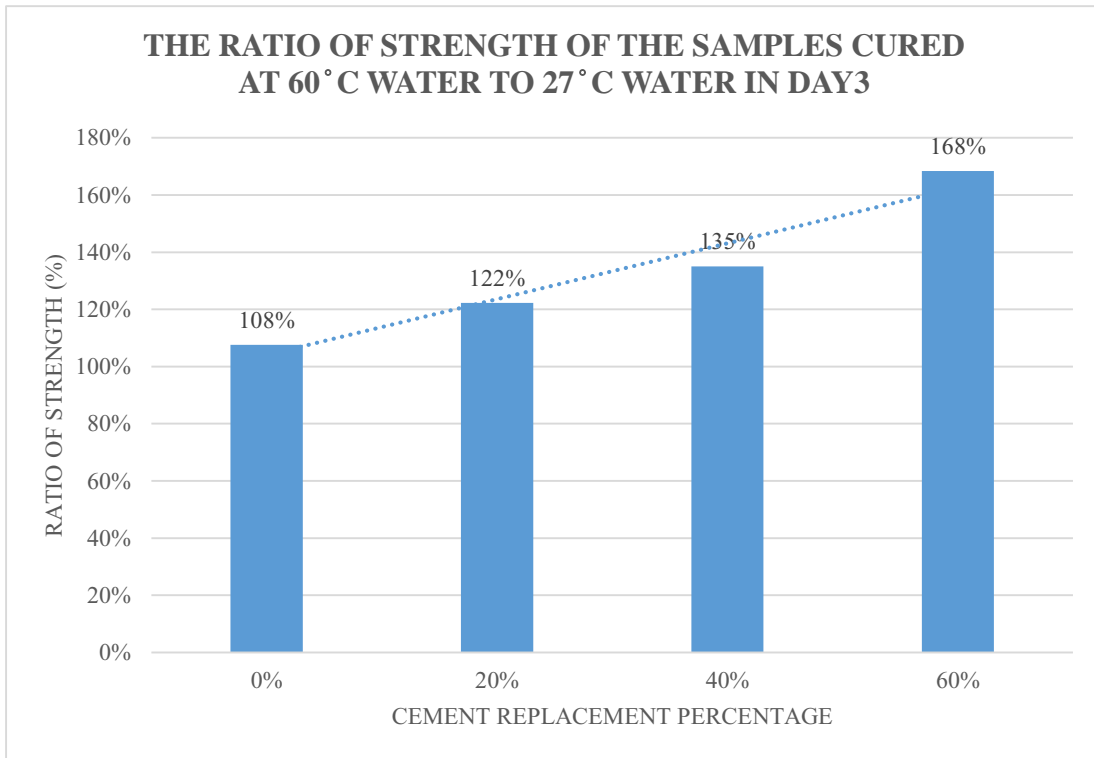

Figure 4.1.2.3-The Ratio of Strength of the samples cured at 60°C to 27°C in day3

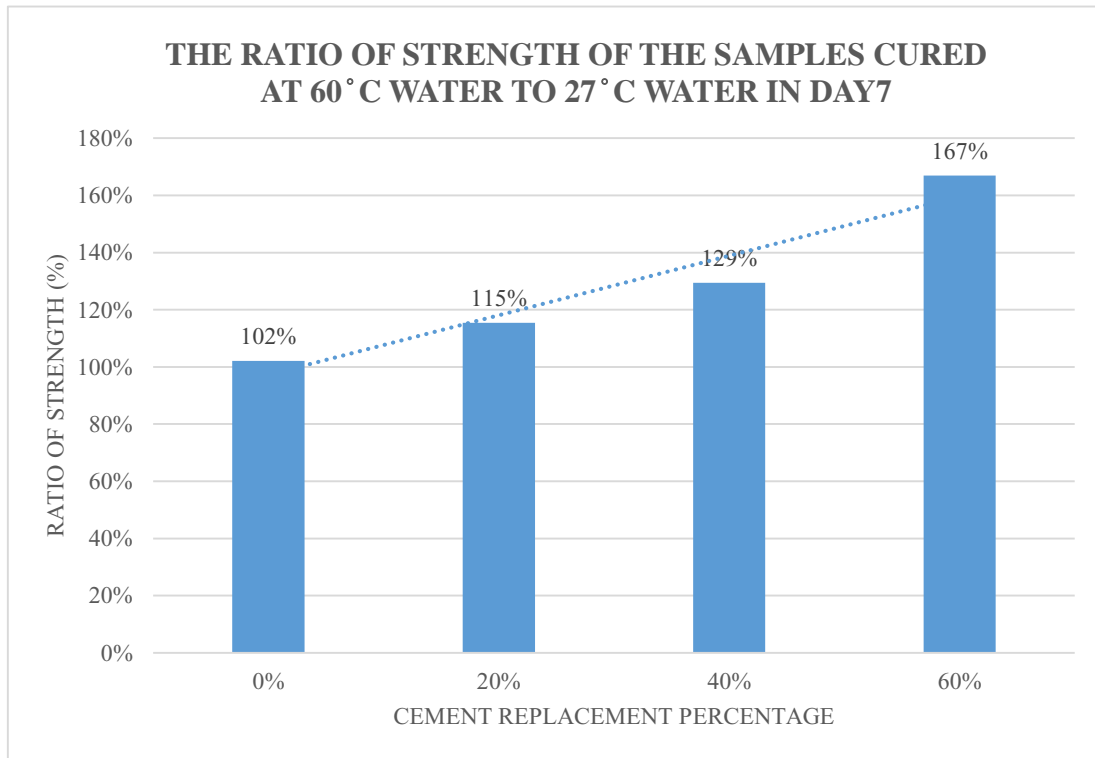

Figure 4.1.2.4-The Ratio of Strength of the samples cured at 60°C to 27°C in day7

### 4.1.3 Later Strength Development of the specimens

The final strength of the concrete are more important than the early strength, as the concrete has to provide adequate strength to support itself and the imposed load afterward. Therefore, the effect of the curing condition and percentage of cement replacement to the final strength will be discussed in here.

**60°C water curing was deleterious to the strength of the samples that contain lesser glass powder as cement replacement material, but conducive to the samples that contain more glass powder, namely 40% and 60% cement replacement samples. The air cured samples exhibit the lowest strength among all samples in different curing conditions.** As shown in figure 4.1.3.1, the compressive strength of the 0% cement replacement samples that were cured at air, 27°C water and 60°C water were 41, 46 and 42 Mpa respectively. For the compressive strength of the 20% cement replacement samples that were cured at air, 27°C water and 60°C water were 26, 33 and 31 Mpa respectively. For the compressive strength of the 40% cement replacement samples that were cured at air, 27°C water and 60°C water were 21, 22 and 23 Mpa respectively. For the compressive strength of the 60% cement replacement samples that were cured at air, 27°C water and 60°C water were 12, 13 and 14 Mpa respectively. According to this result, only the samples that contain 40% and 60% glass powder as cement replacement material could be benefited by using 60°C water curing. To understand the result clearly, Figure 4.1.3.2 showed the ratio of strength of the samples that were cured at 60°C water to 27°C water. The ratio of the strength of samples that were cured at 60°C water to 27°C water were 91%, 98%, 104% and 104%, for samples with 0%, 20%, 40% and 60% cement replacement.

The reason that air cured samples exhibit a lower strength is that, they could not acquire sufficient water to finish the hydration. While the deleterious effect of 60°C water to compressive strength could be explained by the influence of crossover effect

(Elsageer, Millard, & Barnett), which the particles inside the cement form themselves in a quick manner in high temperature water curing and disabled them to form uniformly, so the final structures were messy and the compressive strength would be lowered. As a result of crossover effect, the strength of the samples with 0% and 20% cement replacement would not be benefited by 60°C water curing. However, probably that crossover effect is less significant to the samples with more glass powder, so the 40% and 60% cement replacement samples still exhibit a better of strength in 60°C water curing than those were cured in 27°C water.

There are a few drawbacks of using high temperature water curing. Firstly, only by applying high temperature water curing could not result in a significant growth in the final strength of the concrete, but even sometimes may weaken the structure. For the samples with 0% cement replacement and cured at 60°C water only achieve 91% of the strength of the samples that cured in 27°C water. Secondly, the influence of high temperature water curing on final strength of the samples was similar to the influence of air curing. For the samples with 0% cement replacement, the strength of the samples that were cured in Air and 60°C water were 41.8 and 42.1 Mpa, which only differed by 0.3Mpa. The above facts seem to diminish the usage of high temperature curing. However, the purpose of high temperature curing is to speed up the strength gain process, so if the question is to justify the usage of high temperature water curing, the rate of early strength gain must be considered.

**Those samples that were cured at 60°C water have shown a significantly high rate of strength gain in the early age.** In Figure 4.1.3.3, the ratio of day3 strength to day60 strength were plotted. Most of the 60°C water cured samples have achieved almost 70% of their day60 strength in age3, only the samples of 40% cement replacement was significantly lower than the average; while for those were cured at

27°C water achieved only about 40-60% of their day60 strength. This result could certainly justify the use of high temperature water curing. It also means that most of the cement hydrations and pozzolanic reactions took place within the first three day for those samples that were cured at 60°C water. However, it seems that the effect of different water curing temperatures were not obvious for the 40% cement replacement samples.

**The final strength of the specimen decreased when the percentage of cement replacement increased.** It is believed that the size of the glass powder used in this project was too large, so the pozzolanic activity exhibited is not significant and cause the decrease of strength.

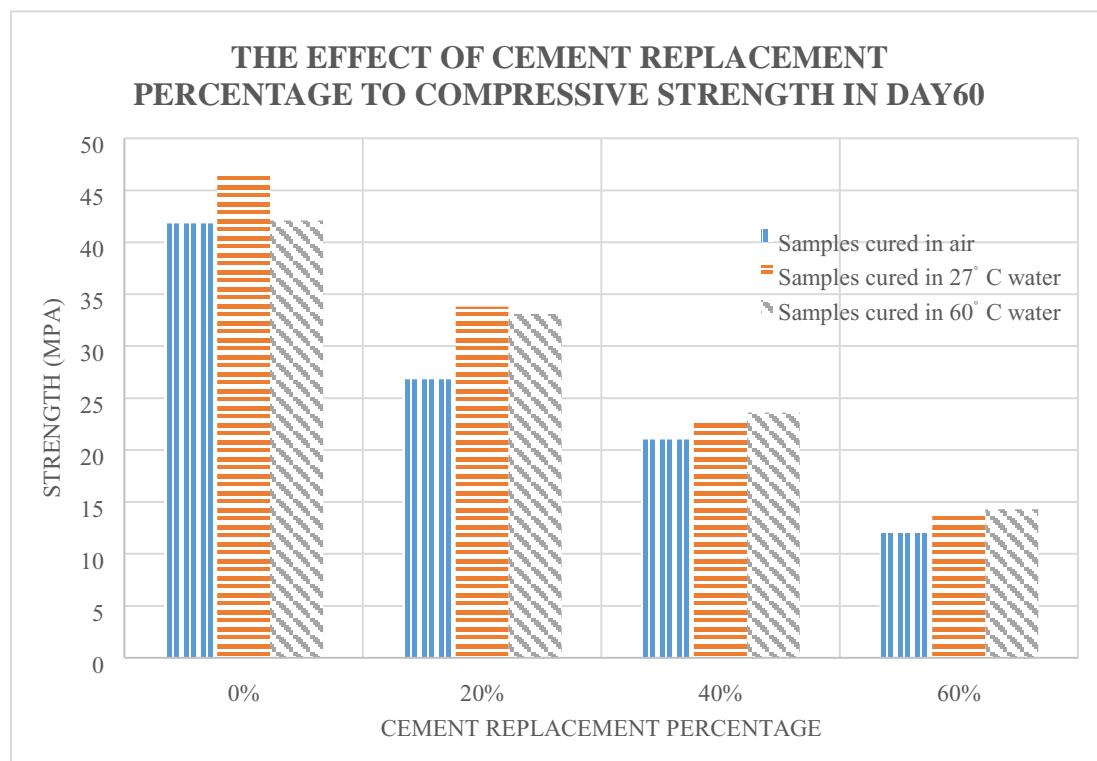

Figure 4.1.3.1-The compressive strength of the samples with different cement replacement percentage in different curing conditions in day60

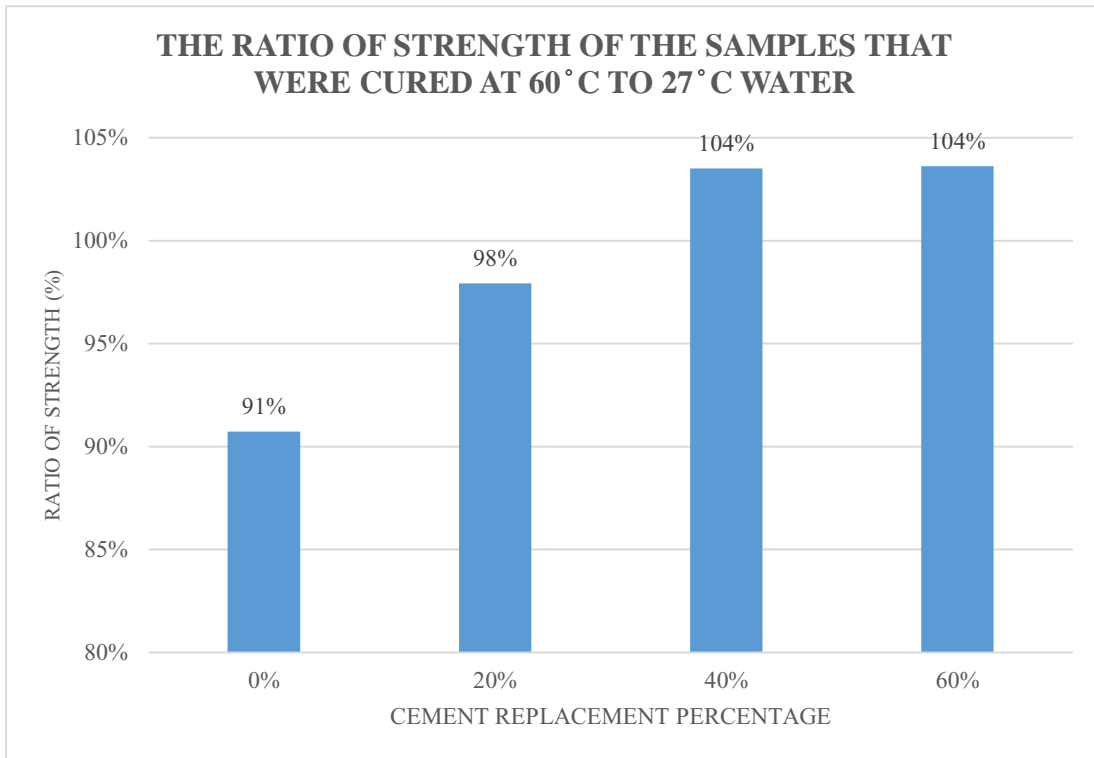

Figure 4.1.3.2-The ratio of strength of the samples that were cured at 60°C water to 27°C water

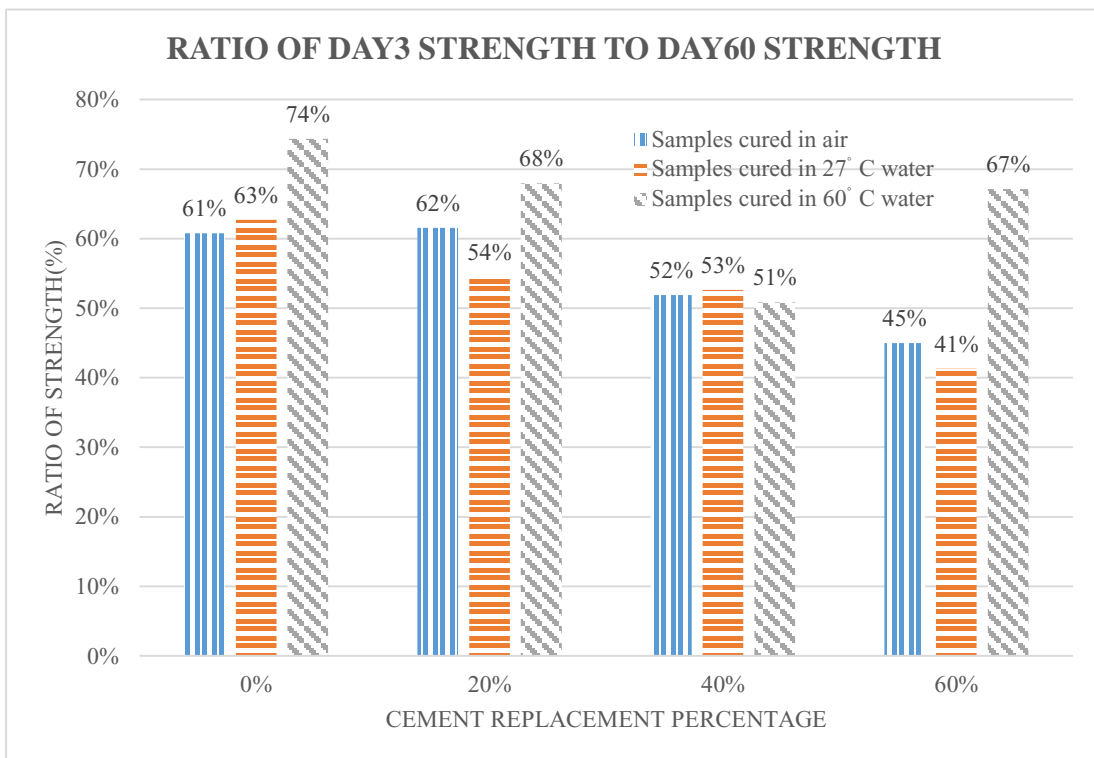

Figure 4.1.3.3-The ratio of day3 strength to day60 strength



#### 4.1.4 Strength Activity Index

Strength activity index is the ratio of strength of the samples with cement replacement material to plain cement mortar. The pozzolanic material use in this project is glass powder. If the samples achieved a higher strength than the control, the strength activity index will be larger than 100% and so on.

**The day 60 strength activity index of the specimens were low. Only the 20% cement replacement samples which cured at 60°C water could achieve a strength activity index higher than 75%.** Figure 4.1.4.1 has shown the strength activity index of the samples in day60. For the air cured samples, the strength activity index of the 20%, 40% and 60% cement replacement samples were 64%, 50% and 29% respectively. For the 27°C water cured samples, the strength activity index of the 20%, 40% and 60% cement replacement samples were 73%, 49% and 30% respectively. For the 60°C water cured samples, the strength activity index of the 20%, 40% and 60% cement replacement samples were 79%, 56% and 34% respectively. This showed that the glass powder used in this research could not provide a strong effect on the increasing the strength of the mortars; the reason behind is probably because the glass powder used is not fine enough. This idea could be supported by some of the research such as Matos 2012 and Shi, Wu 2005, which they suggested only fine glass powder could provide a satisfying strength activity index.

**The strength activity index could be correlated with the cement replacement percentage by linear equations;** the graph that showed this idea was plotted in figure 4.1.4.2. The slope of the specimens cured in air, 27°C water and 60°C water are -1.25, -1.21 and -1.10 respectively. It seems that when curing temperature increased, the slope of the respective graph increased. Another research by Pereira, 2012 also have recorded

the same idea too. This finding could be used to estimate the strength of the samples of different cement replacement percentage. However, this estimation could only be applied on glass powder of larger size, as finer glass powder could alter the correlation.

**Finer glass powder could exhibit another form of correlations, where the strength activity index rise before going downhill when the cement replacement percentage increased.** According to a research (Pereira-de-Oliveira, Castro-Gomes, & Santos, 2012), showed that the strength activity index increased from 100% to 102% when the cement replacement percentage increased from 0% to 10%. After this increase, the strength activity index then decreased with the increased of cement replacement percentage. The idea was shown in figure 2.1.3.1. The rise at 10% cement replacement percentage was not recorded in this current project. It was believed that the reason of this increase at 10% cement replacement percentage was due to the fine size of the glass powder, as the glass powder that used in Pereira's research was in a comparable size with the cement which was very fine.

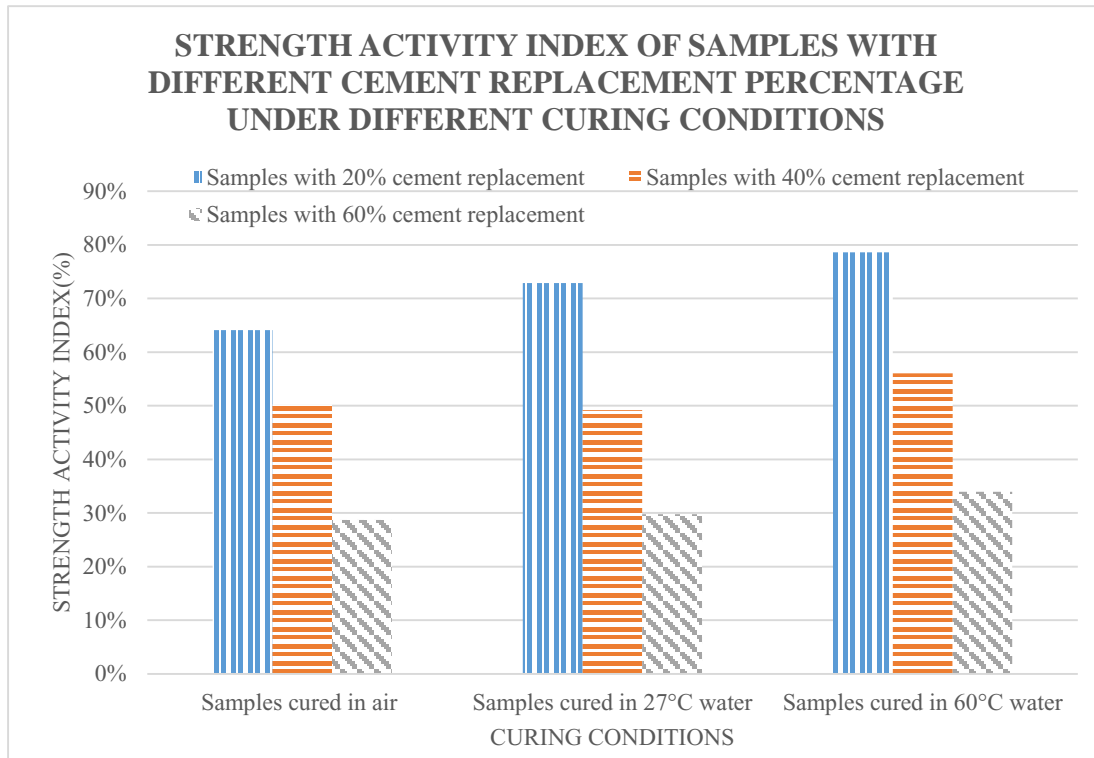

Figure 4.1.4.1- Strength activity index of samples with different cement replacement percentage under different curing conditions

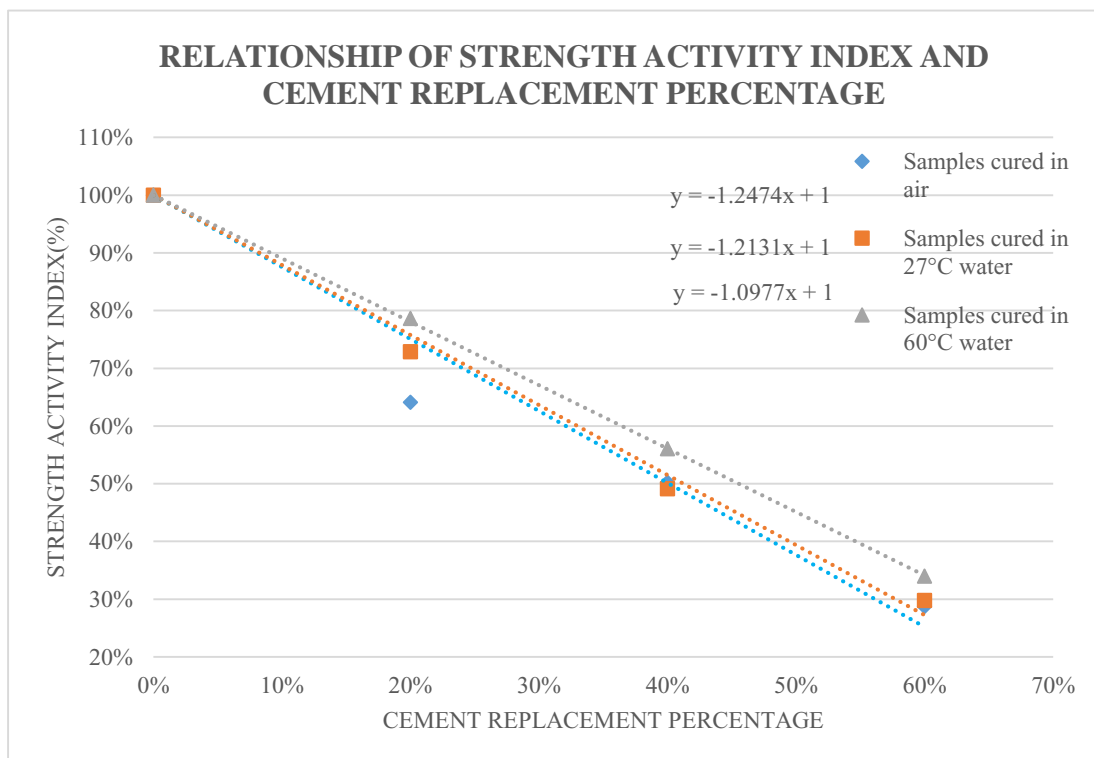

Figure 4.1.4.2-Relationship of strength activity index and cement replacement percentage

## 4.2 Sorptivity

### 4.2.1 Outline

It was found that there is an optimum cement replacement percentage for the specimen to achieve a lower Sorptivity. It was also found that curing condition were crucial to the development of Sorptivity. An unexpected phenomenon also happened in the air cured samples, the pulse velocity is lower in Age 28 than Age60. The mentioned facts were demonstrated in the following sequences:

1. Effect of Curing Condition
2. Effect of Cement Replacement percentage

### 4.2.2 The Effect of Curing Condition

**The air cured specimens performed poorer in sorptivity than the water cured samples in all ages;** a lower Sorptivity was better. Take the 60°C water and the air cured samples as an example. In Figure 4.2.2.1, the percentage of difference of sorptivity in day 60 between the air cured and 60°C water cured samples were plotted, the sorptivity in day 60 of the 60°C water cured samples were 51%, 71%, 83% and 72% of that of the air cured sample for 0%, 20%, 40% and 60% cement replacement samples respectively. This result was attributed to the property of air cure (Bai, Wild, & Sabir, 2002); the specimens that were cured in air could not undergo sufficient hydration due to insufficient water.

**Between the two water cured groups-27°C water cure and 60°C water cure- the specimens that were cured at 60°C water achieved a lower sorptivity faster in age7.** Figure 4.2.2.2-4.2.2.5 have shown the sorptivity of samples of different cement

replacement percentage. In age 7, the sorptivity of the 60°C water cured specimens were 15%, 18%, 33% and 109% lower than the 27°C water cured specimens for 0%, 20%, 40% and 60% cement replacement samples. **The improvement in percentage of sorptivity in day7 to day60 of the 60°C water cured samples were mainly not as good as the 27°C water cured samples** This could be seen on Figure 4.2.2.6, where it has shown the improvement of sorptivity in percentage from day7 to day60. The reduction for 0% cement replacement samples between age 7 and 60 were -3%, 44% and 33% for the samples cured in air, 27°C water and 60°C water respectively. For the reduction of 20% cement replacement samples between age 7 and 60 were 5%, 94% and 108% for the samples cured in air, 27°C water and 60°C water respectively. For the reduction of 40% cement replacement samples between age 7 and 60 were 16%, 399% and 254% for the samples cured in air, 27°C water and 60°C water respectively. For the reduction of 60% cement replacement samples between age 7 and 60 were 2%, 155% and 50% for the samples cured in air, 27°C water and 60°C water respectively. Almost all the 27°C water cured samples had a better improvements in sorptivity except for those samples with 20% cement replacement. More than that, the average improvements of the 40% cement replacement samples were the most significant.

**The sorptivity in day60 of the 60°C water cured samples were better than those cured at 27°C water.** Figure 4.2.2.7 showed the mentioned idea. From the above results, it could be concluded that, 60° water curing was conducive to the development of the sorptivity in all ages. The effect of high temperature water curing to sorptivity was more significant in samples of higher cement replacement percentage, especially the 40% cement replacement samples. At last, again, Air cure is not a good condition for the development of sorptivity.

There was an unexpected phenomenon observed. Some of the specimens would exhibit a higher sorptivity in age 60 than that of age 28, see figure 4.2.2.2, this observation was mainly seen in the samples that were cured in air. As the capillary pores should normally be reduced when time goes by. Probably, without a proper water curing process was deleterious to the samples in regards of sorptivity.

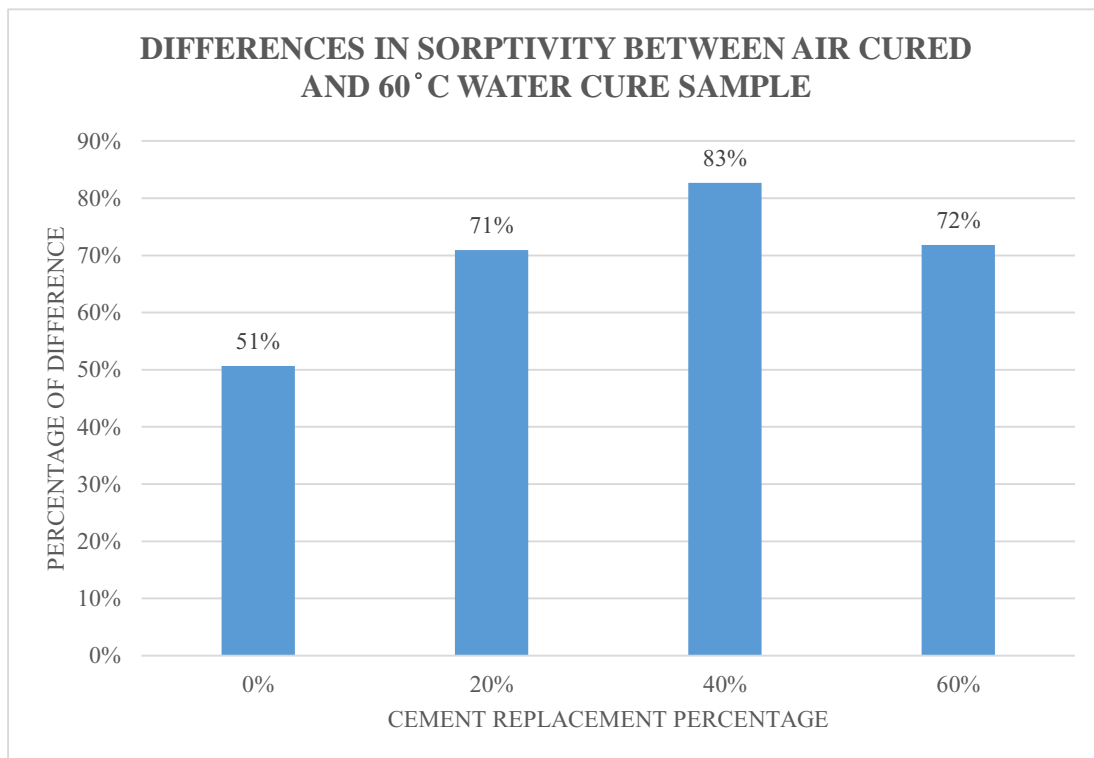

Figure 4.2.2.1- Differences in Sorptivity between Air cured and 60°C water cure sample

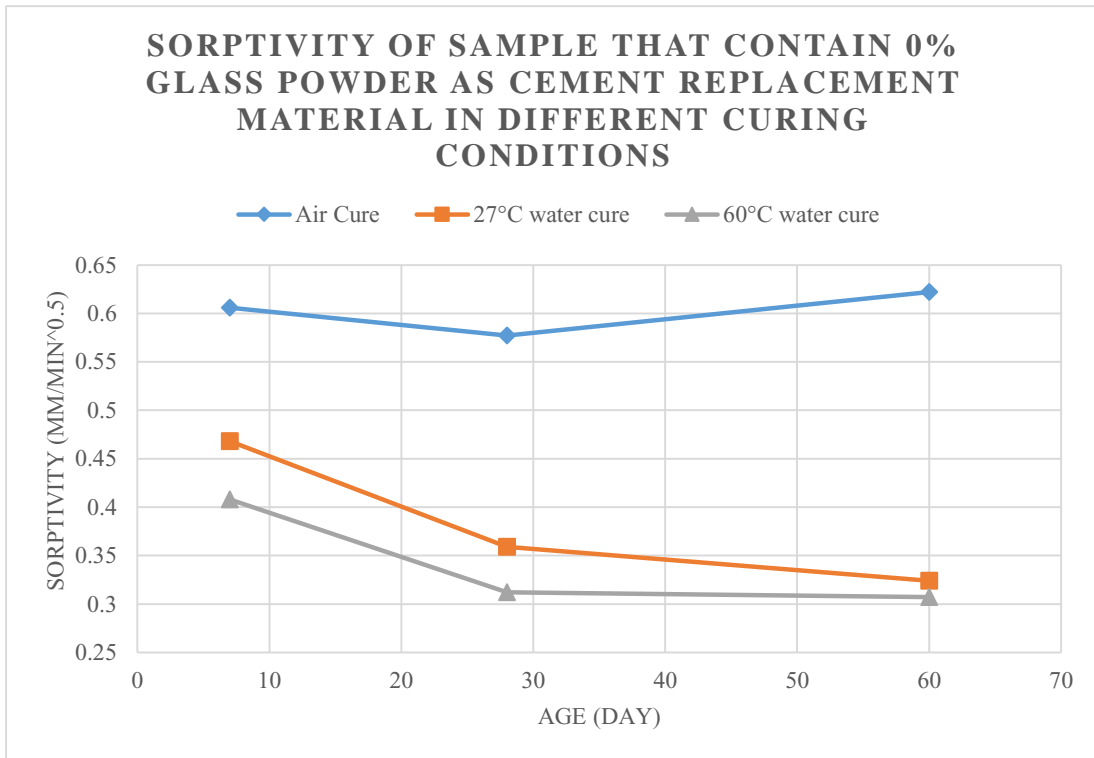

Figure 4.2.2.2-Sorptivity of Sample that Contain 0% Glass Powder as Cement Replacement Material in Different Curing Conditions

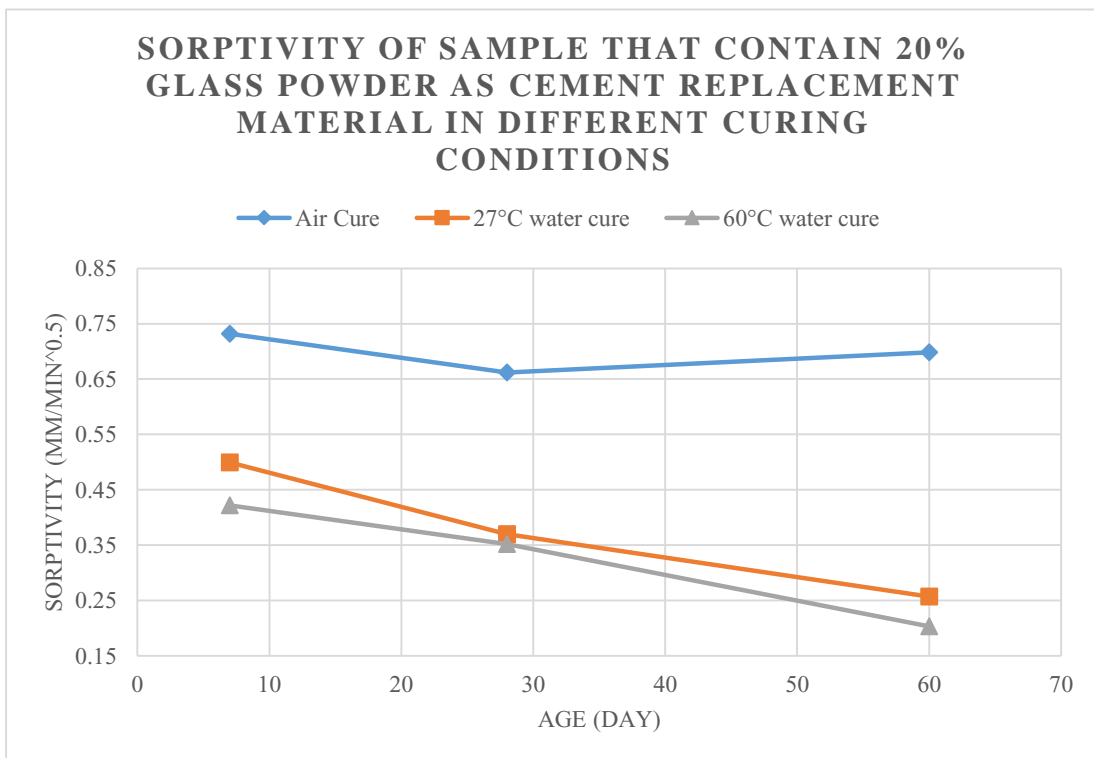

Figure 4.2.2.3-Sorptivity of Sample that Contain 20% Glass Powder as Cement Replacement Material in Different Curing Conditions

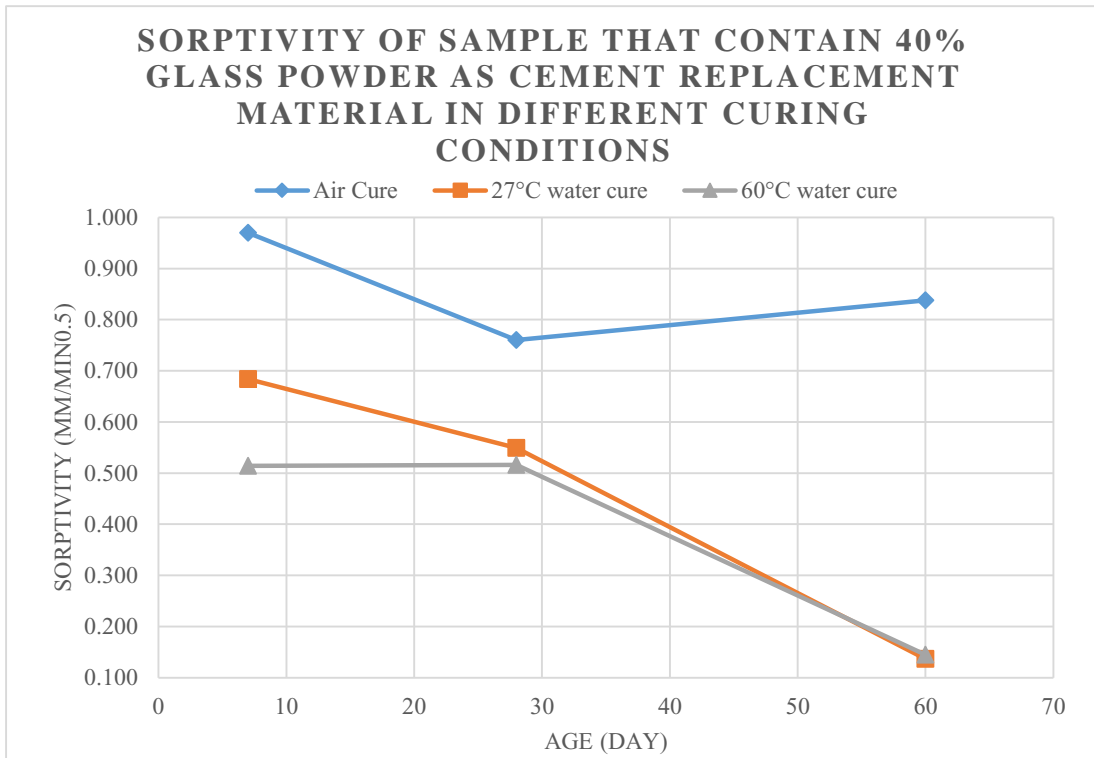

Figure 4.2.2.4-Sorptivity of Sample that Contain 40% Glass Powder as Cement Replacement Material in Different Curing Conditions

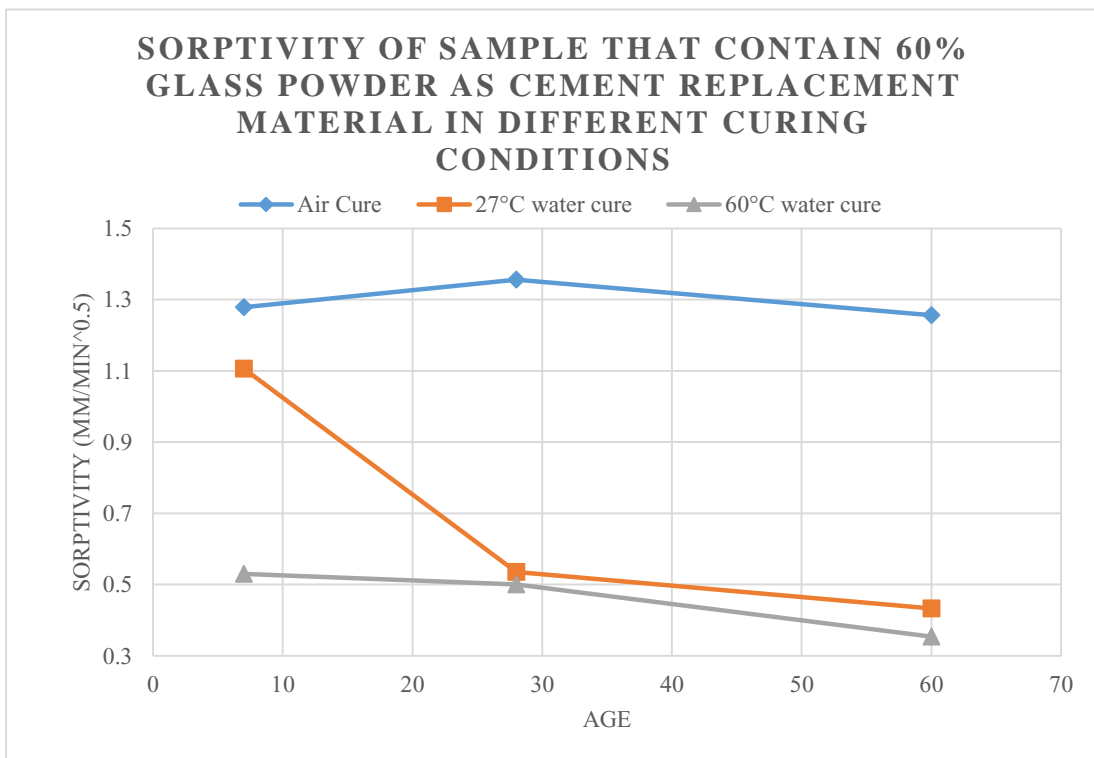

Figure 4.2.2.5-Sorptivity of Sample that Contain 60% Glass Powder as Cement Replacement Material in Different Curing Conditions



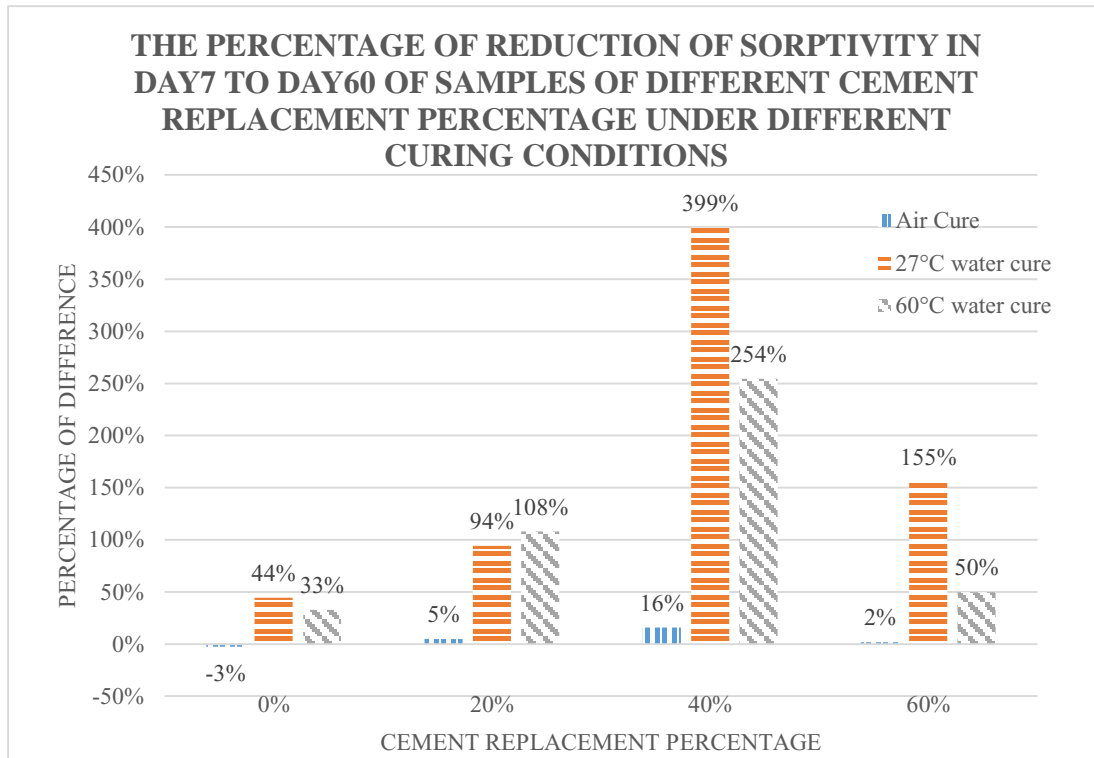

Figure 4.2.2.6-The reduction of sorptivity of samples of different cement replacement percentage under different curing conditions from day7 to day60

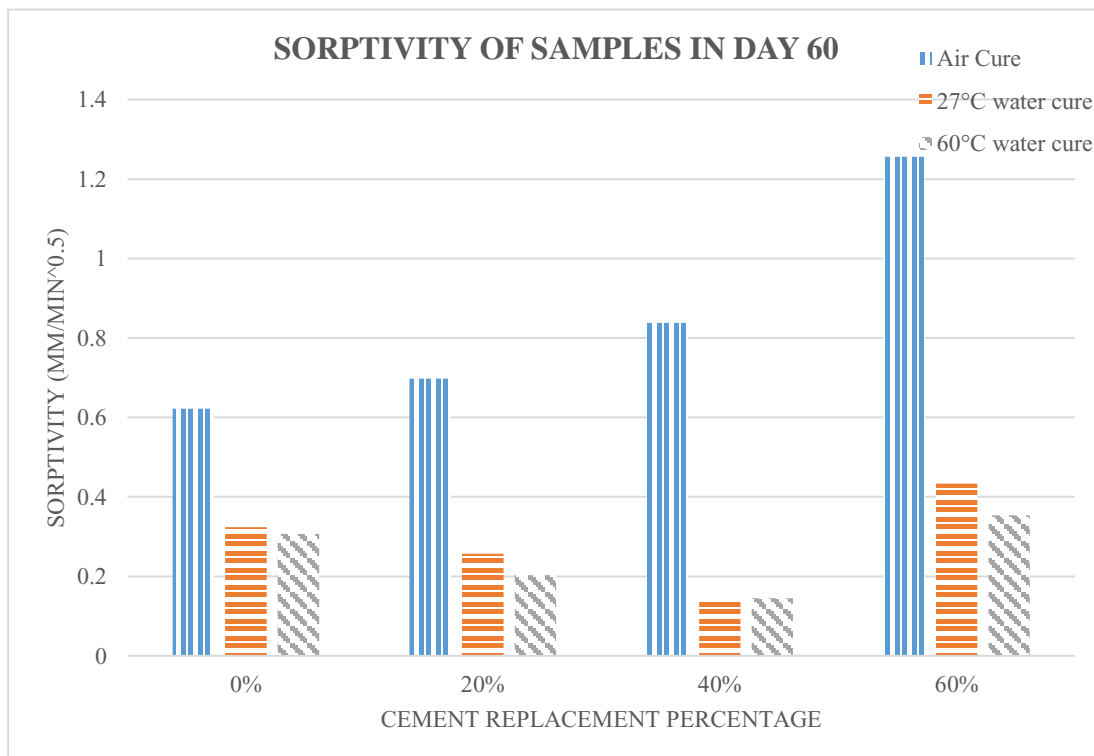

Figure 4.2.2.7-Sorptivity of samples in day60

### 4.2.3 The Effect of Cement Replacement Percentage

**The day 7 sorptivity increased when the cement replacement percentage was increased.** Figure 4.2.3.1 to 4.2.3.3 have shown the idea. For air cured samples, the sorptivity of the samples that contained 0%, 20%, 40% and 60% glass powder as cement replacement material were 0.606, 0.732, 0.970 and 1.279(mm/min<sup>0.5</sup>) respectively. For 27°C water cured samples, the sorptivity of the samples that contained 0%, 20%, 40% and 60% glass powder as cement replacement material were 0.468, 0.499, 0.684 and 1.106(mm/min<sup>0.5</sup>) respectively. For 60°C water cured samples, the sorptivity of the samples that contained 0%, 20%, 40% and 60% glass powder as cement replacement material were 0.408, 0.422, 0.514 and 0.530(mm/min<sup>0.5</sup>) respectively.

**The samples that contain 40% glass powder as cement replacement material and cured in water had the lowest sorptivity.** The effect of replacement percentage to sorptivity in day60 was not the same as day7, except for the air cured samples. For the sorptivity of the water cured samples in day60, the samples with 40% cement replacement were the lowest and followed by samples with 20% cement replacement, samples with 0% cement replacement and samples with 60% cement replacement respectively.

As the samples contain 40% glass powder as cement replacement material were found to have the lowest sorptivity under water curing. It was believe that 40% cement replacement percentage was the optimum value for sorptivity, so its characteristics were investigated more.

**The effect of 27°C water curing and 60°C water curing to the sorptivity in day60 of the samples that contain 40% cement replacement material was similar.** The sorptivity of the 27°C water cured and 60°C water cured samples 0.137 and 0.145 (mm/min<sup>0.5</sup>). This result was shown in figure 4.2.2.7

**It is also found that most of the reduction in sorptivity of 40% cement replacement specimens that were cured in water happened in day 28 to 60. The reductions of sorptivity in percentage in age 7 to 28 are 25% and 0% for the samples cured at 27°C water and 60°C water respectively, while the reduction on sorptivity in age 28 to 60 are 301% and 256%.**

To conclude, by curing the samples that of 40% cement replacement in 60°C water could provide a satisfying sorptivity in both the early and later age.

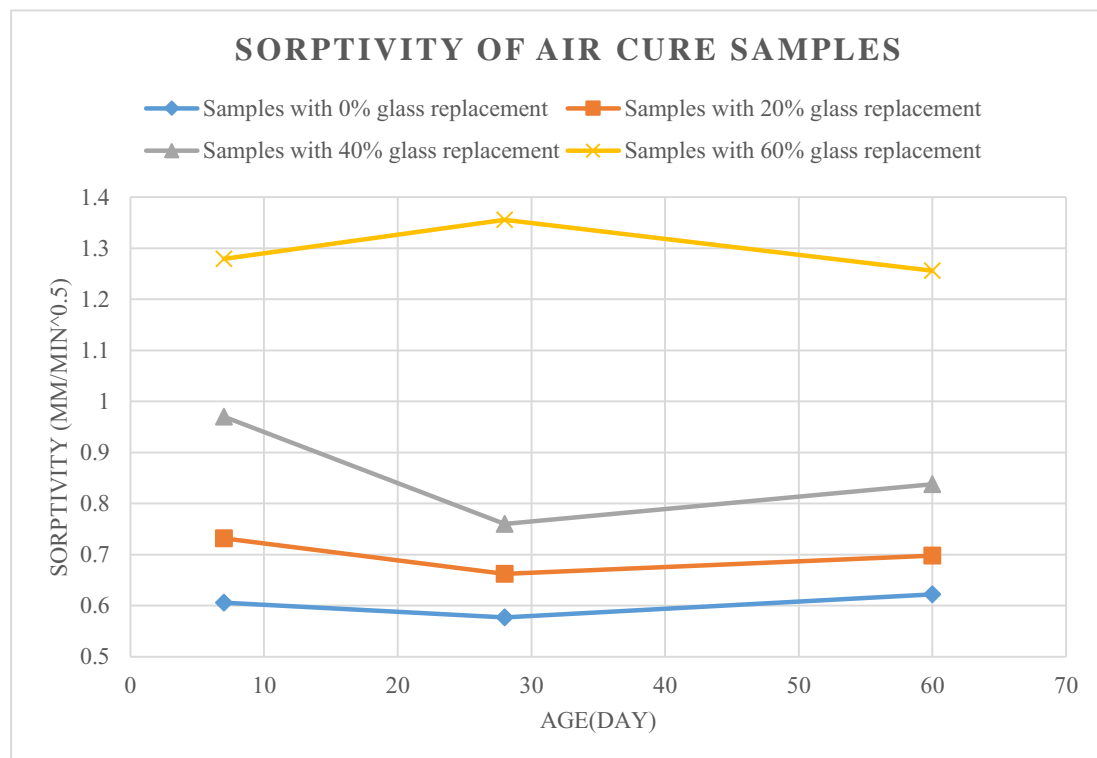

### SORPTIVITY OF 27° C WATER CURED SAMPLES

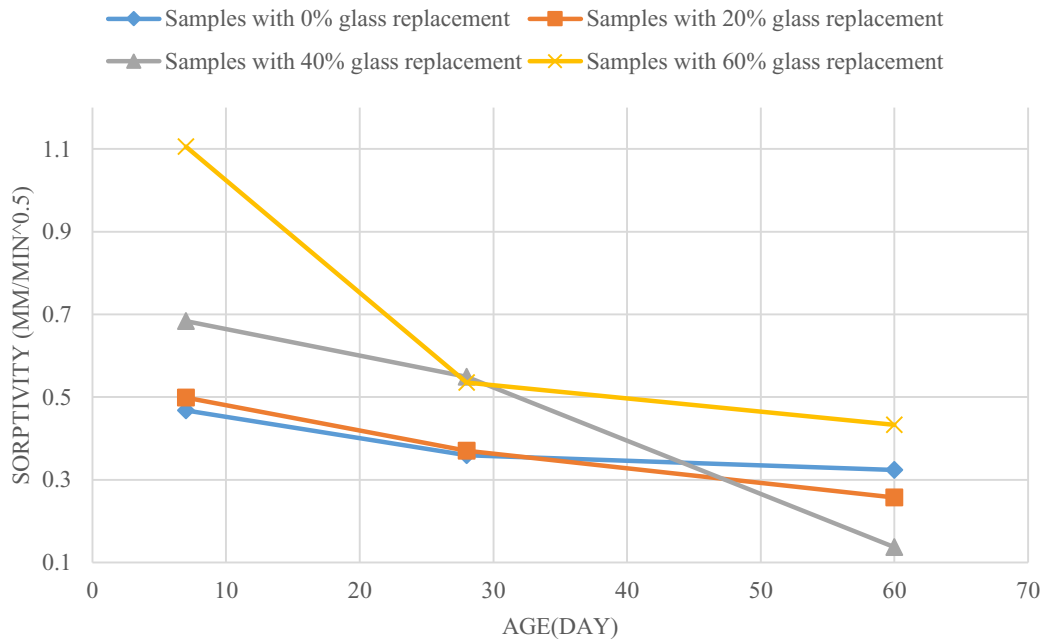

### SORPTIVITY OF 60° C WATER CURED SAMPLES

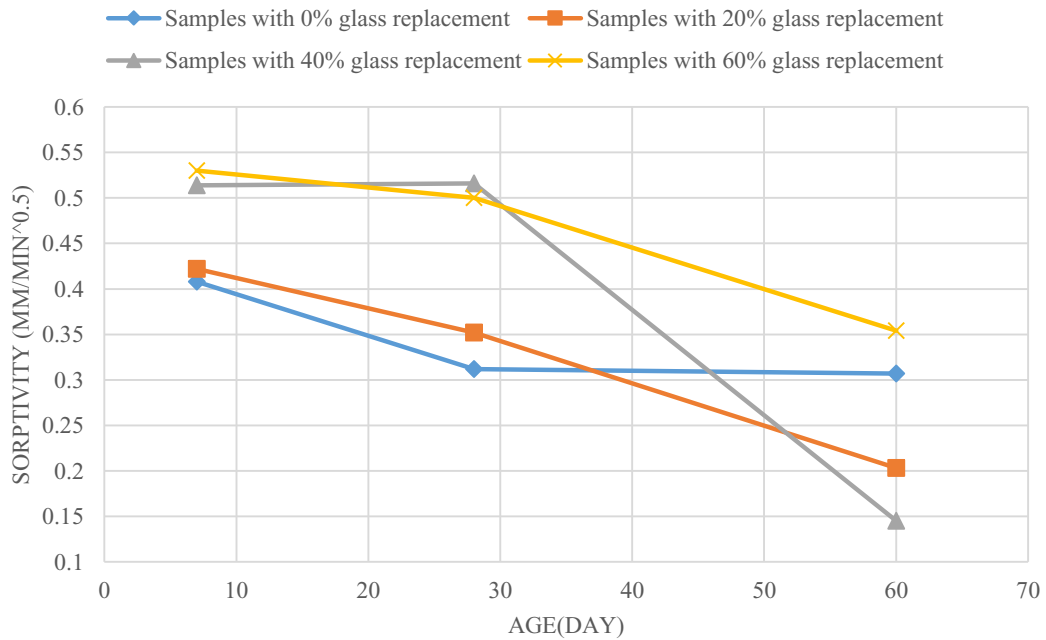

## 4.3 Pundit Result

### 4.3.1 Outline

According to the research that mentioned in the literature review section, it is known that most of the pulse velocity were gained within the first day. The rest of the gain in velocity in stage 3 are minimal compared to those gain in stage 1 and 2. (Zhang, Zhang, Liu, Zhang, & Liu, 2012).

The samples in the current research are believed to follow such development too. The experiments that are done in this research in question mainly aim to reveal and investigate the Stage 3 development of the pulse velocity in different conditions. In order to discuss the movements and characteristics of the pulse velocity clearly, the results will be analyzed in the following directions:

1. The Growth in Pulse Velocity
2. The Correlation of Pulse Velocity and Compressive Strength
3. E-Value

### 4.3.2 The Growth in Pulse Velocity

#### i. The effect of curing conditions:

For the Early age:

**The day 3 sorptivity of the 60°C water cured samples were the best, followed by 27°C water cured samples and air cured samples respectively.** Figure 4.3.2.1 to 4.3.2.4 have shown the idea. For the 0% cement replacement samples, the pulse velocity were 3.431, 3.724 and 3.745(km/s) respectively for the sample cured in Air, 27°C water and 60°C water. For the 20% cement replacement samples, the pulse velocity were

3.170, 3.546 and 3.604(km/s) respectively for the sample cured in Air, 27°C water and 60°C water. For the 40% cement replacement samples, the pulse velocity were 2.809, 3.215 and 3.336(km/s) respectively for the sample cured in Air, 27°C water and 60°C water. For the 60% cement replacement samples, the pulse velocity were 2.407, 2.825 and 3.110(km/s) respectively for the sample cured in Air, 27°C water and 60°C water.

The reasons that account for the higher early age pulse velocity in 60°C water cured samples were as follow. **Firstly**, the cement hydration product were produced at a higher pace in high water temperature curing. The hydration products filled up the pores faster and increased the overall bulk density which is conducive for the ultrasound to travel across the specimen. Also higher concentration of hydration products could allow the glass powder to react faster too. **Secondly**, the pozzolans could be activated thermally by high water temperature. (MA, S, & Mohamed., 2012 ) This means that the glass powder will react faster too in high water temperature curing and form the path for the ultrasound to pass faster.

For the later age:

**The day60 sorptivity of the 27°C water cured samples were the best, followed by 60°C water cured samples and air cured samples respectively.** The above statement was valid for most of the situations, except for the samples that contain 20% glass powder as cement replacement material. The results have shown in figure 4.3.2.1 to 4.3.2.4. For the 0% cement replacement samples, the pulse velocity are 3.697, 4.163 and 3.945 respectively for the sample cured in Air, 27°C water and 60°C water. For the 20% cement replacement samples, the pulse velocity are 3.497, 3.802 and 3.854 respectively for the sample cured in Air, 27°C water and 60°C water. For the 40% cement replacement samples, the pulse velocity are 3.226, 3.861 and 3.839 respectively

for the sample cured in Air, 27°C water and 60°C water. For the 60% cement replacement samples, the pulse velocity are 2.874, 3.724 and 3.591 respectively for the sample cured in Air, 27°C water and.

It could be concluded that, air curing seems to be deleterious to the development of pulse velocity; the samples cured in 60°C water could not provide a better pulse velocity in day60 than the samples cured in 27°C water.

For the air cured samples, it was believed that they could not acquire enough water to finish the hydration process, so the pulse velocities were lower. For the better performance in pulse velocity in the samples that were cured in 27°C water was believed to be contributed by the following effect: Cross-over effect. A more heterogeneous distribution of the hydration product was formed in 60°C water curing, which is deleterious to the pulse velocity in day60. The high water temperature curing would cause the samples to hydrate in an accelerated rate in the early age and somehow lead to the foresaid distribution. Conversely, this situation do not exist in the samples cured in 27°C water, as the hydration rate is moderate which would allow more time for the dissolved ions to diffuse around the sample before hydration precipitate. This action would lead to a more even distribution. That was why the ultrasound could travel at a higher speed in the samples that were cured at 27°C water than 60°C water in a longer curing age (Zhang, Zhang, Liu, Zhang, & Liu, 2012).

More than that, the average pulse velocity of all the samples have only increased for an average of 12% from age3 to age 60. This result certified that the growth of speed in Stage 3 is minimal.

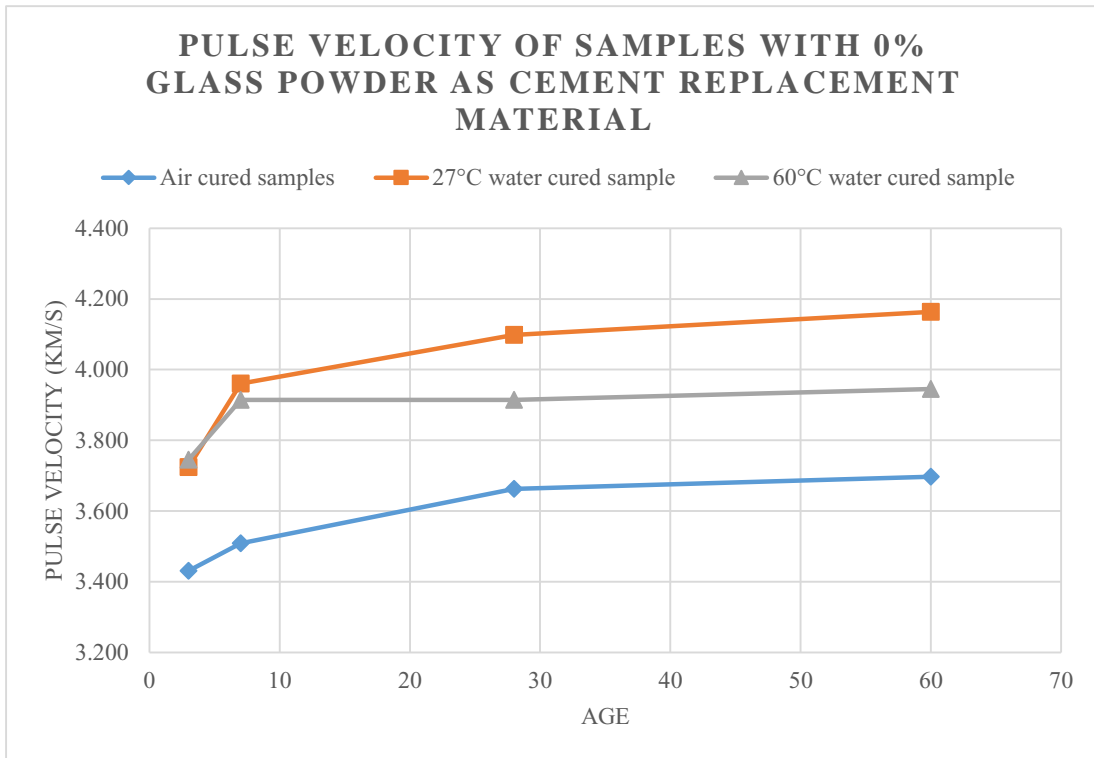

Figure 4.3.2.1-Pulse velocity of samples with 0% glass powder as cement replacement material

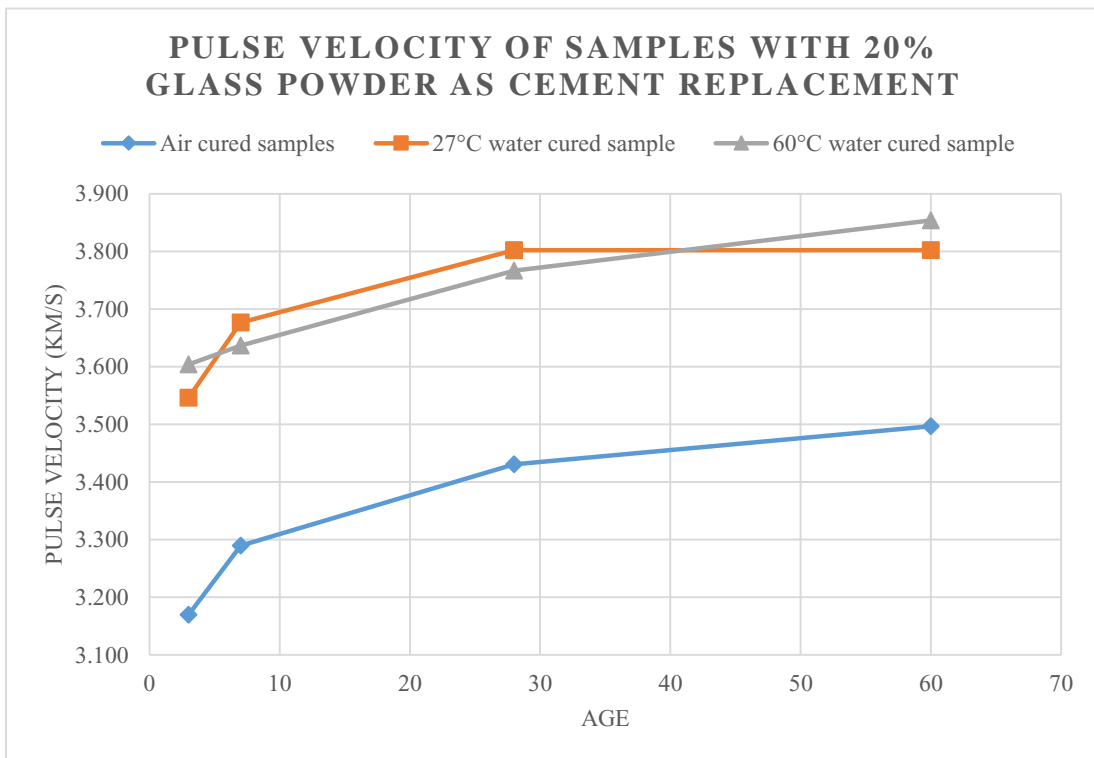

Figure 4.3.2.2-Pulse velocity of samples with 20% glass powder as cement replacement material



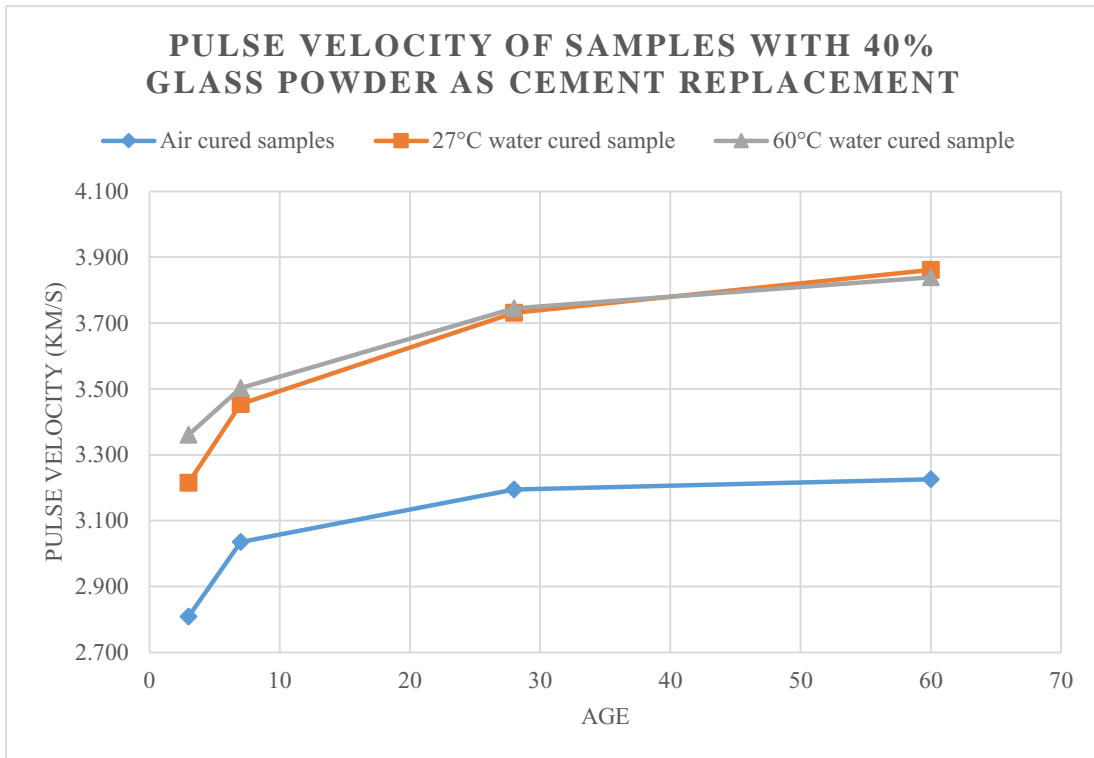

Figure 4.3.2.3-Pulse velocity of samples with 40% glass powder as cement replacement material

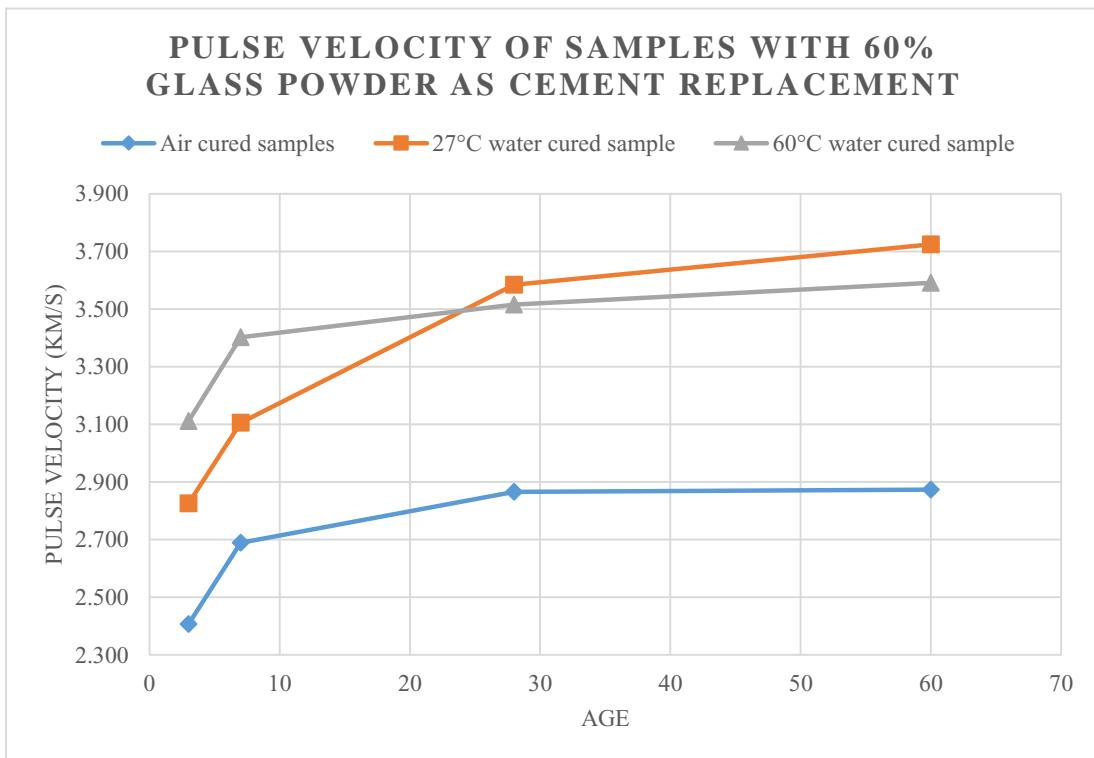

Figure 4.3.2.4-Pulse velocity of samples with 60% glass powder as cement replacement material

**ii. The effect of cement replacement percentage:**

**The day3 pulse velocity of the samples decrease with the increase of cement replacement percentage. The trend in day 60 was also similar.** In addition, the pulse velocity of the samples that contain 40% glass powder as cement replacement material under water curing were very close to the samples of 20% cement replacement; sometimes the sample of 40% cement replacement could exhibit a higher pulse velocity than the samples of 20% cement replacement. The relevant ideas were shown in figure 4.3.2.5 to 4.3.2.7

It is believed that the above trend was caused by the large glass particle size. The glass powder that was used in the project was not in a comparable size with cement, so they would probably widen the gap between each of the particles, as the pozzolans occupy the space and displace the cement particles to a farer location. Filler effect of pozzolans, which mentioned earlier in literature review, was not applicable in this research, as the glass particles size was significantly larger than cement. Therefore, the voids and pulse velocity will be larger and higher when more pozzolans were used.

Under proper water curing, the samples that contain 40% glass powder as cement replacement material could exhibit a similar pulse velocity with the sample of 20% cement replacement. It was believed that when 40% of the cement was replaced glass powder, the distribution of the particles in the specimens could be benefited in a good way, so the ultrasound could traveled as fast as in the 20% cement replacement samples.

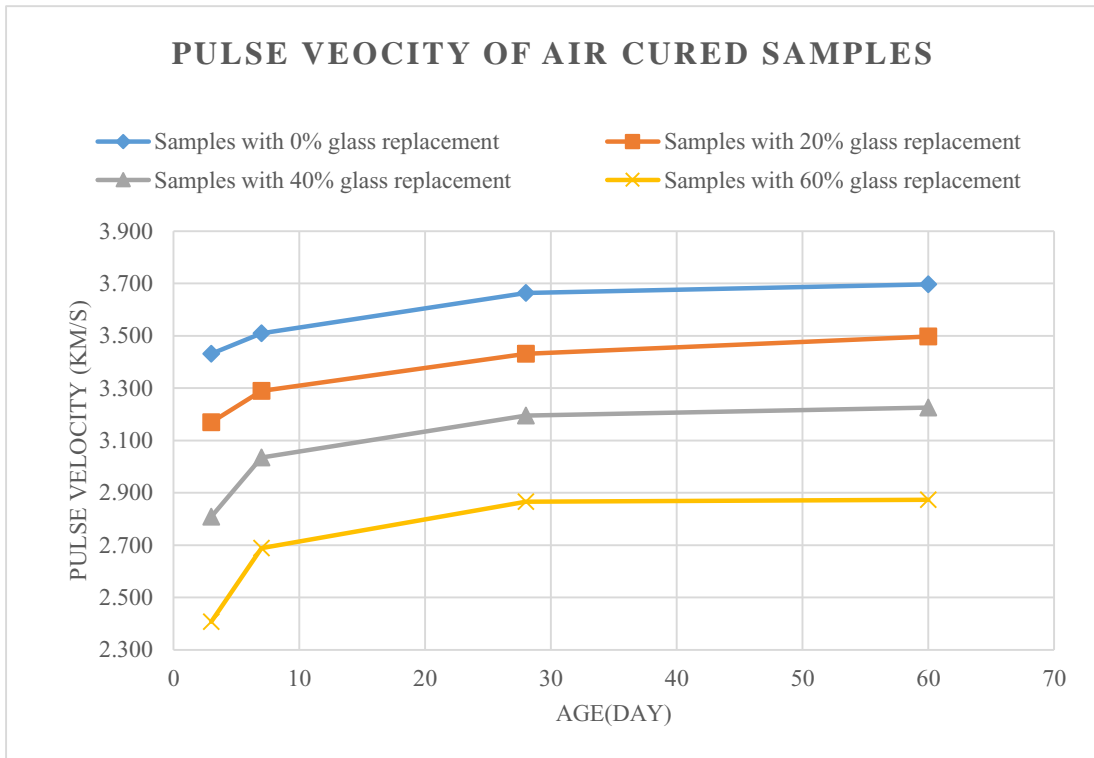

Figure 4.3.2.5-Pulse velocity of air cured samples

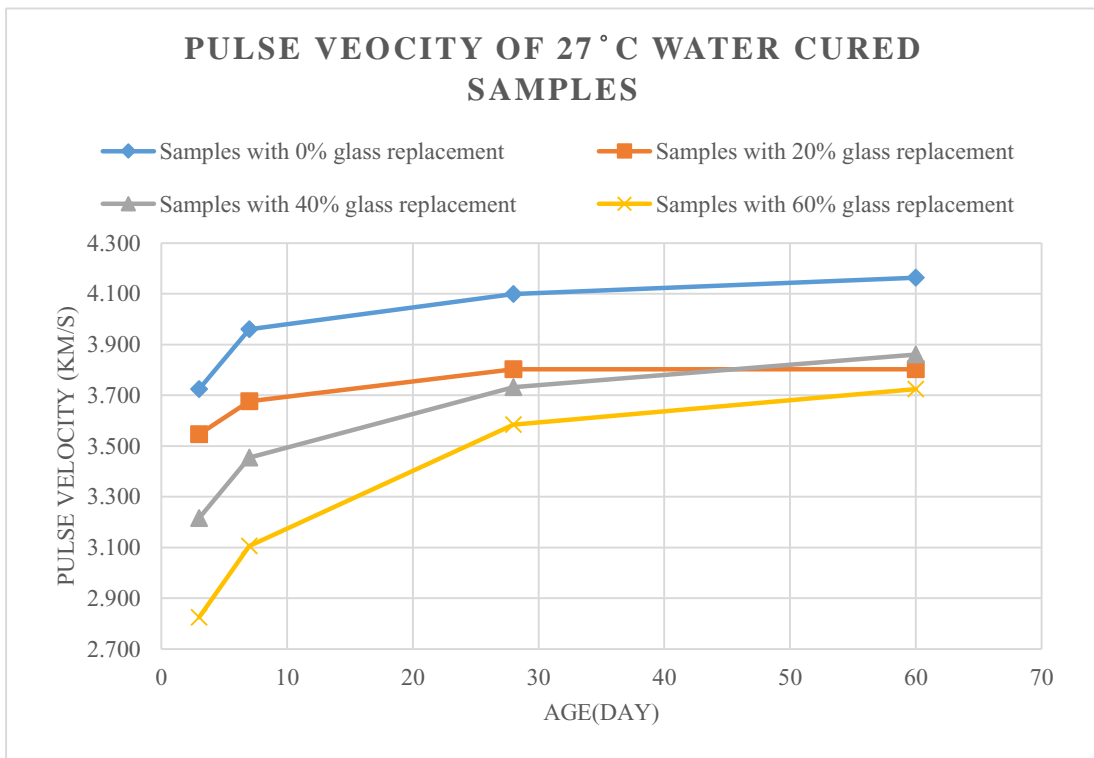

Figure 4.3.2.6-Pulse velocity of 27°C water cured samples

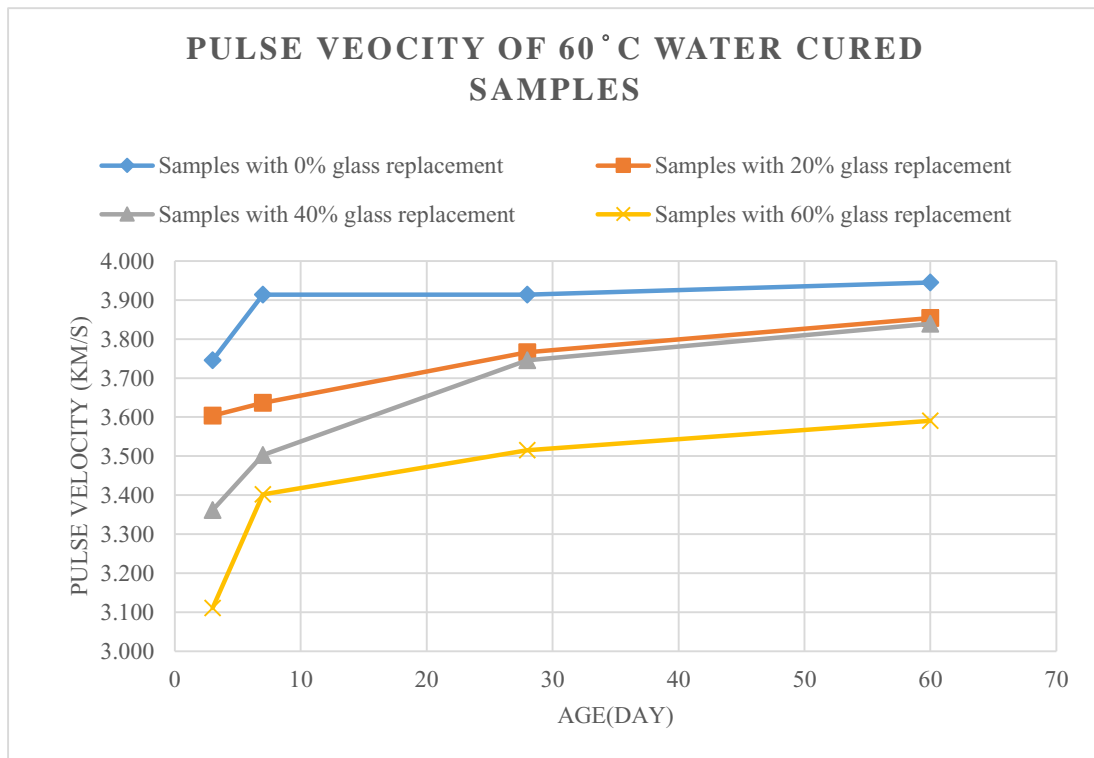

Figure 4.3.2.7-Pulse velocity of 27°C water cured samples

### 4.3.3 Correlation of compressive strength and pulse velocity

Fact about correlations of compressive strength and pulse velocity were obtained in this project, although a one-for-all correlation for compressive strength and pulse velocity has not been shown in this research yet. In order to obtain a one for all correlation, a large number of data have to be processed. This was a major difficulty in this project, as there is not a powerful analyzing tool. To tackle this problem, artificial network was used in some researches. (Trtnik, Kavcic, & Turk, 2009)

**It is found that the correlation between compressive strength and pulse velocity were affected by many parameters, such as curing conditions and cement replacement percentages. This conclusion was arrived by the following three attempts of plotting the graph of compressive strength against the pulse velocity.**

First the compressive strength were plotted against the pulse velocity randomly, see figure 4.3.3.1, where every data in this project were used. However, such method could not obtain a reliable correlation, as the discrepancy was large, where the compressive strengths could be differed by 30Mpa for the same pulse velocity. Secondly, the data were attempted to be plotted with the data from the samples with the same cement replacement percentage, but the correlation was again not satisfying. At last, the figure 4.3.3.2 to 4.3.3.5 were plotted by using the compressive strength and pulse velocity of the samples of the same cement replacement percentage and curing condition. This time some sensible correlations could be seen. It could be finally figured that the correlation between compressive strength and pulse velocity could be essentially presented by a linear equation, but the how much do the parameters control the slope and the y-intercept of these straight line were still unknown.

Although the correlations in figure 4.3.3.2 to 4.3.3.5 were not mature, it could still preliminarily conclude that, when the cement replacement percentage increase, the average slope of the linear correlation of the samples in different curing conditions will decrease.

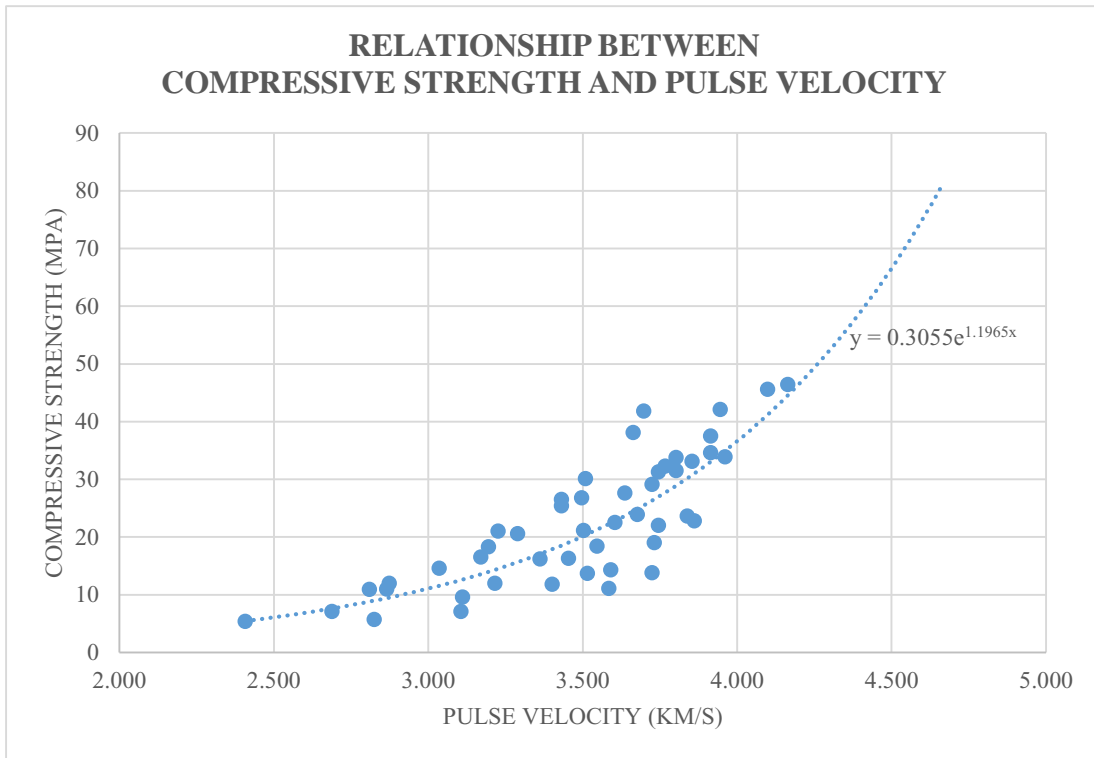

Figure 4.3.3.1-Relationship between compressive strength and pulse velocity

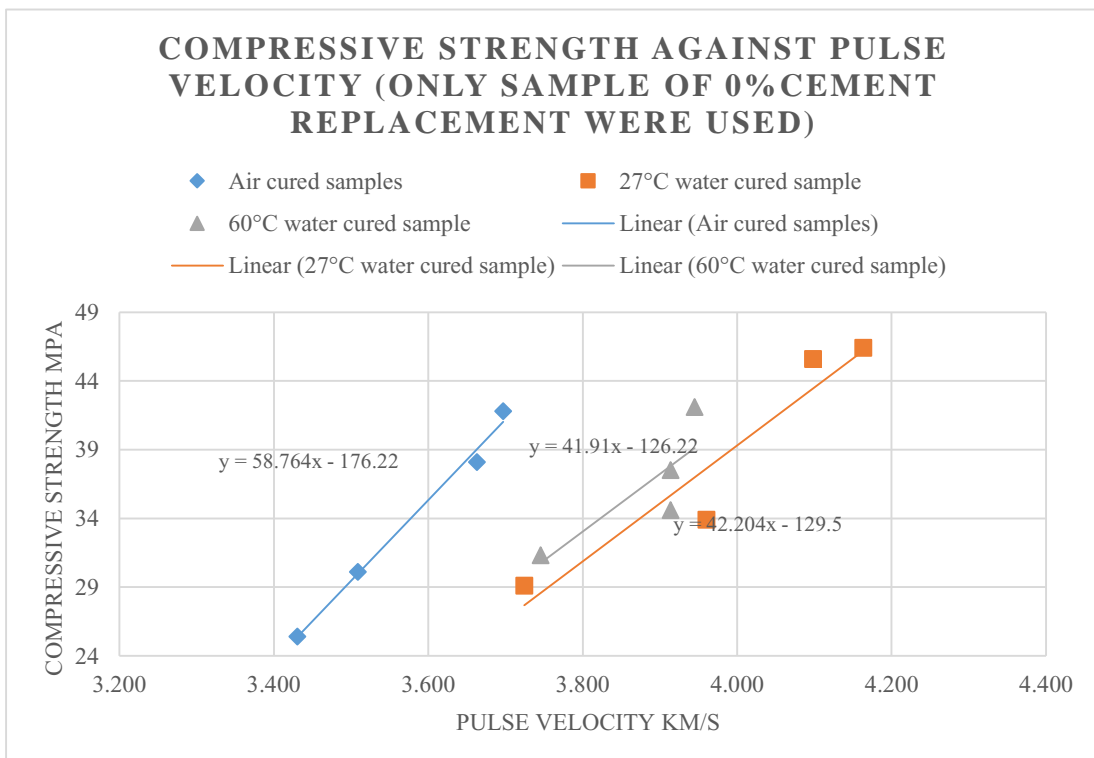

Figure 4.3.3.2-Compressive strength against pulse velocity (only sample of 0% cement replacement were used)

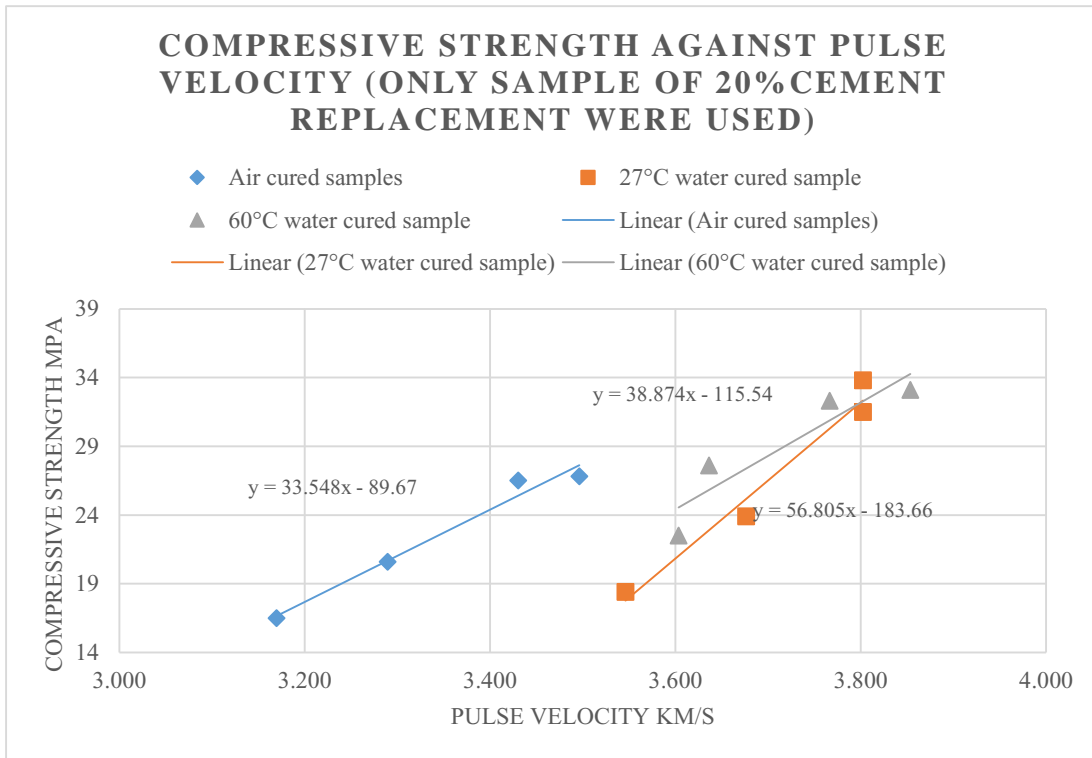

Figure 4.3.3.3-Compressive strength against pulse velocity (only sample of 20% cement replacement were used)

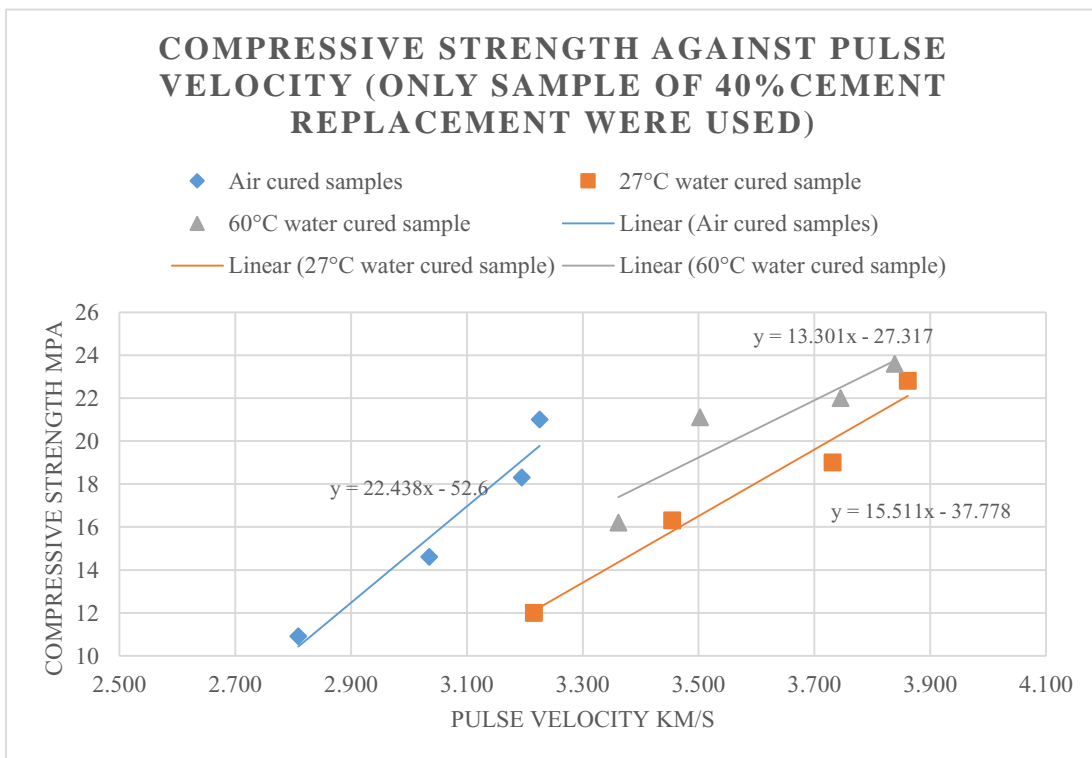

Figure 4.3.3.4-Compressive strength against pulse velocity (only sample of 40% cement replacement were used)

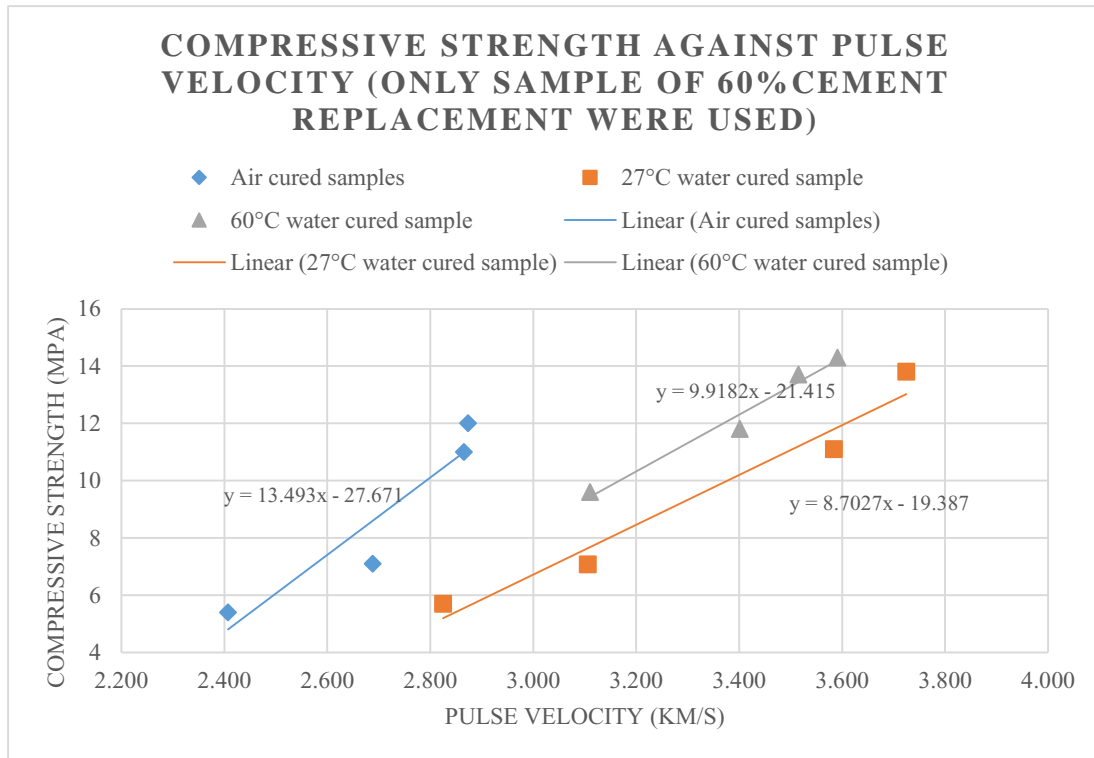

Figure 4.3.3.5-Compressive strength against pulse velocity (only sample of 60% cement replacement were used)

#### 4.3.4 Dynamic Modulus of Elasticity

The dynamic modulus of elasticity were calculated and plotted on figure 4.3.4.1. For the air cured samples, the dynamic modulus of elasticity were 28352, 22811, 20884 and 15200 Mpa for the sample that contained 0%, 20%, 40% and 60% glass powder as cement replacement material respectively. For the 27°C water cured samples, the dynamic modulus of elasticity were 36065, 29992, 32763 and 28663 Mpa for the sample that contained 0%, 20%, 40% and 60% glass powder as cement replacement material respectively. For the 60°C water cured samples, the dynamic modulus of elasticity were 30041, 30659, 32586 and 24391 Mpa for the sample that contained 0%, 20%, 40% and 60% glass powder as cement replacement material respectively.

It could be concluded that: **firstly**, air cured samples performed not as good as the water cured samples; **secondly**, the dynamic modulus of elasticity of the air cured samples decrease with the increase of cement replacement percentage; **thirdly**, the



27°C water cured samples normally performed better than 60°C water cured samples in dynamic modulus of elasticity; **fourthly**, for the 27°C water cured samples, the dynamic modulus of elasticity dropped when the cement replacement percentage was increased from 0% to 20%. However, as the cement replacement percentage was increased from 20% to 40%, a slight rise was recorded. When the cement replacement percentage was further increased to 60%, the dynamic modulus of elasticity decreased again.

Air cured samples generally performed worse than the water cured samples in many characteristic, such as the compressive strength and sorptivity. Dynamic modulus of elasticity also were better in water cured samples. This is attribute to the insufficient hydration of the specimen.

It was believed that the 40% cement replacement percentage were conducive to the packing of the specimens, so the dynamic modulus of elasticity were higher than the others.

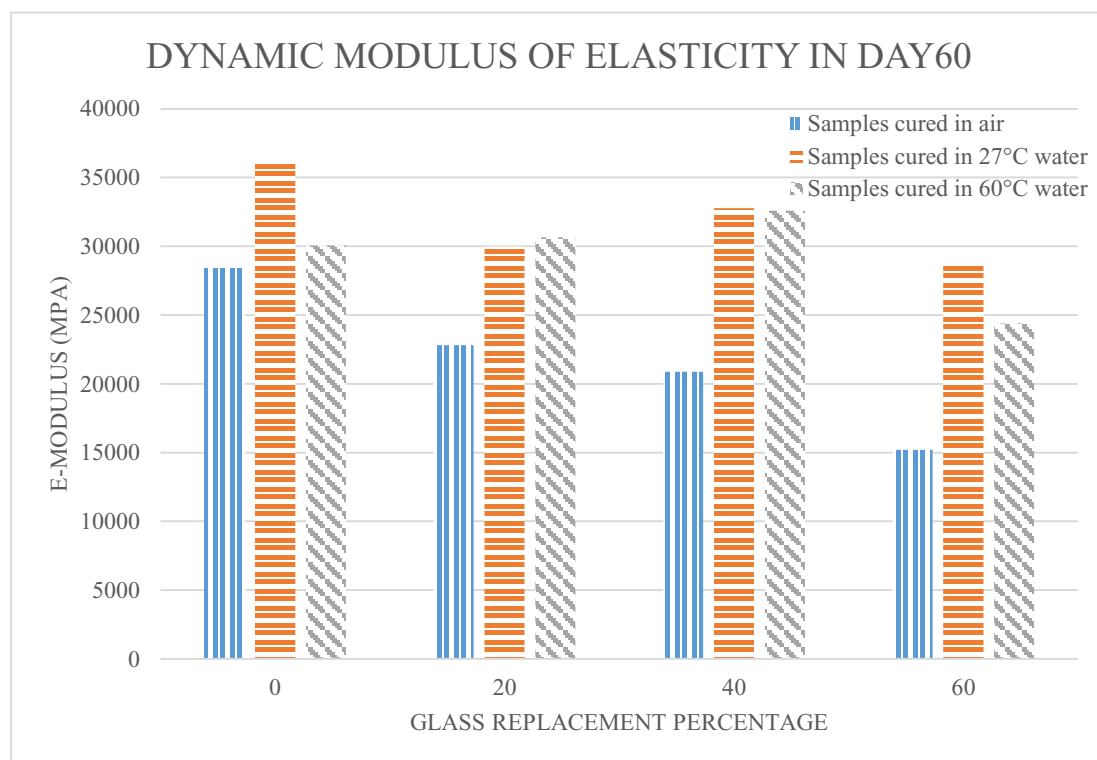

Figure 4.3.4.1-Dynamic modulus of elasticity in day 60

# CHAPTER 5 CONCLUSIONS AND RECOMMENDATIONS

## 5.1 Conclusions

The influences of curing conditions and level of cement replacement were discussed. The effects of the two variables could be preliminarily concluded. Firstly, 60°C water curing has a different influences on the properties of mortar. It could be conducive to the day 60 sorptivity, but deleterious to the day 60 compressive strength. Secondly, among all level of cement replacement (0%, 20%, 40%, 60%), samples with 40% cement replacement had some satisfying performance in some of the properties. The detail conclusions were listed in the following:

1. For the early compressive strength, high water temperature curing was conducive to the result. Most the samples could obtain about 70% of their final strength in age 3. However, the effect of high water temperature curing to early compressive strength was not significant in the sample of 40% cement replacement.
2. The final compressive strength of the samples cured at 60°C water were affected, as a result of crossover effect. Instead, 27°C water curing was conducive to the final compressive strength of the samples.
3. The day60 compressive strength were lowered by the increase of cement replacement level.

4. The strength activity index of the samples were low in this research, as the glass powder used was not fine enough. More than that, the strength activity index could be correlated with the cement replacement level, where the slope of the linear correlation were controlled by the curing conditions. The slope of the linear equation will be steeper when the curing temperature decrease. i.e.  $60^{\circ} \rightarrow 27^{\circ} \rightarrow \text{Air cure}$
5. In regard of sorptivity,  $60^{\circ}\text{C}$  water curing was beneficial to the sorptivity of the samples in all ages. Among all curing condition, air curing was the least beneficial to the development of sorptivity.
6. The performance of Sorptivity were the best in the samples that contain 40% cement replacement material, glass powder.
7. In regard of pulse velocity, the samples cured in  $27^{\circ}\text{C}$  water exhibited the best result, instead of those cured in  $60^{\circ}\text{C}$  water. The pulse velocity of the air cured samples were the worse.
8. The pulse velocity in most of the case was the best in the 0% cement replacement samples, followed by 20% cement replacement samples, 40% cement replacement samples and 60% cement replacement samples respectively. This result was cause by the large glass particle size.
9. It could be preliminarily concluded that the pulse velocity could correlate with the compressive strength by linear equations. However, the correlation was very sensitive to many parameters, such as curing conditions and cement replacement

level. Although all the correlation was not mature, it could be concluded that the slope of the linear correlation decreased when the level of cement replacement increased.

10. 40% cement replacement is the optimum level for the E-value to develop.

## **5.2 Recommendations**

The following recommendations were made to facilitate the work of other researchers or someone who is interested to use glass powder as a cement replacement material.

1. The glass powder has to be fine enough to produce an acceptable result.
2. 60°C water curing was suggested to be applied only in the early age, day 0 to 7, in order to save energy. This is because the improvement of specimens under 60°C water curing in day 7 to day 60 were similar to those under 27°C water curing.
3. More research on the correlation of compressive strength and pulse velocity were encouraged, as it has not been found in this research.
4. More investigations on specimens with 40% cement replacement were encouraged. As it was an optimum percentage for some of the characteristics of the specimens, such as E-value, sorptivity. It was believed that the samples with 40% of cement replacement have some kind of special property.

## REFERENCES

- A. Shayan, A. X. (1999). Utilisation of glass as a pozzolanic material in concrete. *ARRB-TR internal report RC91132*.
- A. Shayan, A. X. (2004). Value added Utilisation of waste glass in concrete. *Cement and Concrete Research* 34, 81-89.
- Ahmad Shayan, A. X. (2006). Performance of glass powder as a pozzolanic material in concrete: A field trial on concrete slabs. *Cement and Concrete Research* 36, 457-468.
- Bai, J., Wild, S., & Sabir, B. (2002). Sorptivity and strength of air-cured and water-cured PC–PFA–MK concrete and the influence of binder composition on carbonation depth. *Cement and Concrete Research* 32, 1813–1821.
- Caijun Shi, YanZhong Wu, Chris Riefler, & Hugh Wang. (2005). Characteristics and pozzolanic reactivity of glass powders. *Cement and Concrete Research* 35, 987-993.
- Elsageer, M. A., Millard, S. G., & Barnett, S. J. (n.d.). Strength development of concrete containing coal fly ash under different curing temperature conditions.
- Ezziane, K., Bougara, A., Kadri, A., H.Khelafi, & E.Kadri. (2007). Compressive strength of mortar containing natural pozzolan under various curing temperature. *Cement & Concrete Composites* 29, 587-593.
- H, U., & S., U. (1980). Influence of pozzolans on the hydration of C3A. *Seventh international congress on the chemistry of cement*, 23-9.
- M. Pattengil, T. S. (1973). Use of ground glass as a pozzolan. *Albuquerque Symp. on utilisation of waste glass in Secondary Products*, 137-153.
- MA, A.-E. A., S, A. E., & Mohamed., H. (2012 ). Physico-chemical and mechanical characteristics of pozzolanic cement pastes and mortars hydrated at different curing temperatures. *Constr Build Mater* 26, 310-6.
- Matos, A. M., & Coutinho, J. S. (2012). Durability of Mortar using waste glass powder as cement replacement. *Construction and Building Material* 36, 205-215.
- Matos, A., & Sousa-Coutinho, J. (2012). Durability of mortar using waste glass powder as cement replacement. *Construction and Building Materials* 36, 205-215.

- MW, G., SD, A., & DM, R. (1983). Mechanism of hydration of CSF in calcium hydroxide solution . *proceedings of the first international conference on the use of fly ash, silica fume, slag and natural pozzolans in concrete, American Concrete Institue*, 643-64.
- Nash't, Hameed, I., Hameed, A. S., Sadoon, & Abdullah, A. (2002). Ultrasonic Pulse Velocity in Concrete. *NCCLR, Baghdad*.
- Pereira-de-Oliveira, L. A., Castro-Gomes, J. P., & Santos, P. M. (2012). The potential pozzolanic activity of glass and red clay ceramic waste as cement mortar components. *Construction and Building Material 31*, 197-203.
- Pitroda, J., & Umrigar, D. F. (2013). Evaluation of Sorptivity and Water Absorption of Concrete with Partial Replacement of Cement by Thermal Industry Waste (Fly Ash). *International Journal of Engineering and Innovative Technology (IJEIT)*.
- Schwarz, N., Cam, H., & Neithalath, N. (2008). Influence of a fine glass powder on the durability characteristics of concrete and its comparison to fly ash. *cement & Concrete Composite 30*, 486-496.
- Shao, Y., Lefort, T., Moras, S., & Rodriguez, D. (2000). Studies on concrete containing ground waste glass. *Cement and Concrete Research 30*, 91-100.
- Tasdemir, C. (2003). Combined effects of mineral admixtures and curing conditions on the sorptivity coefficient of concrete. *Cement and Concrete Research 33*, 1637-1642.
- Trtnik, G., Kavcic, F., & Turk, G. (2009). Prediction of concrete strength using ultrasonic pulse velocity and artificial neural networks. *Ultrasonics 49*, 53-60.
- Ye, G., Lura, P., Breugel, K. v., & Fraaij, A. (2004). Study on the development of the microstructure in cement-based materials by means of numerical simulation and ultrasonic pulse velocity measurement. *Cement & Concrete Composites 26*, 491-497.
- Zhang, W., Zhang, Y., Liu, L., Zhang, G., & Liu, Z. (2012). Investigation of the influence of curing temperature and silica fume content on setting and hardening process of the blended cement paste by an improved ultrasonic apparatus. *Construction and Building Materials 33*, 32-40.

## APPENDIX

### APP1: Result of Compressive Strength

#### Compressive Strength (Mpa)

Samples	Age (day)	Level of Cement Replacement (%)			
		0%	20%	40%	60%
Samples cured in air	3	25.4	16.5	10.9	5.4
	7	30.1	20.6	14.6	7.1
	28	38.1	26.5	18.3	11
	60	41.8	26.8	21	12
Samples cured in 27 ° C water	3	29.1	18.4	12	5.7
	7	33.9	23.9	16.3	7.1
	28	45.6	31.5	19	11.1
	60	46.4	33.8	22.8	13.8
Samples cured in 60 ° C water	3	31.3	22.5	12	9.6
	7	34.6	27.6	21.1	11.8
	28	37.5	32.3	22	13.7
	60	42.1	33.1	23.6	14.3

## APP2: Result of sorptivity

### Sorptivity (mm/min<sup>0.5</sup>)

Samples	Age (day)	Level of Cement Replacement (%)			
		0%	20%	40%	60%
Samples cured in air	7	0.606	0.732	0.970	1.279
	28	0.577	0.662	0.760	1.356
	60	0.622	0.698	0.838	1.256
Samples cured in 27 ° C water	7	0.468	0.499	0.684	1.106
	28	0.359	0.370	0.549	0.535
	60	0.324	0.257	0.137	0.433
Samples cured in 60 ° C water	7	0.408	0.422	0.514	0.530
	28	0.312	0.352	0.516	0.500
	60	0.307	0.203	0.145	0.354



### APP3: Result of Pulse Velocity

#### Pulse Velocity (km/s)

Samples	Age (day)	Level of Cement Replacement (%)			
		0%	20%	40%	60%
Samples cured in air	3	29.15	31.55	35.6	41.55
	7	28.5	30.4	32.95	37.2
	28	27.3	29.15	31.3	34.9
	60	27.05	30.45	31	34.95
Samples cured in 27 ° C water	3	26.85	28.2	29.75	35.4
	7	25.25	27.2	28.95	32.2
	28	24.4	26.3	26.8	27.9
	60	24.02	26.3	25.9	26.85
Samples cured in 60 ° C water	3	26.7	27.75	31.1	32.15
	7	25.55	27.5	28.55	29.4
	28	25.55	26.55	26.7	28.45
	60	25.35	25.95	26.05	27.85